



FLUKE®

Test Tools Catalog

2012 2013



Digital Multimeters
 Clamp Meters
 Electrical Testers
 Insulation Testers
 Earth Ground Testers
 Installation Testers

Portable Appliance Testers
 Digital Thermometers
 Thermal Imagers
 Distance Meters
 Indoor Air Quality Tools
 ScopeMeter® Test Tools

Power Quality Tools
 Field Calibrators
 Vibration Tester
 Radiation Tester
 EX Test Tools
 Accessories



Contents

Fluke web and electronic newsletter	1
New from Fluke	2-3
Fluke Combo Kits	4-5

Application/background articles	6
Fluke After Sales Service	7
Fluke where safety is built in	8-9
Fluke web/campaign	10

Digital Multimeters	11
DMM Selection Guide	12
280 Series Digital Multimeters	13
233 Remote Display Multimeter	14
80 Series V Digital Multimeters	15
170 Series Digital Multimeters	16
110 Series II Digital Multimeters	17
27 II / 28 II Rugged Industrial Multimeters	18
77 IV Digital Multimeter	19
88V Automotive Meter	20
8845A/8846A 6.5 Digit Precision Multimeters	21
8808A 5.5 Digit Multimeter	22

Clamp Meters and Electrical Testers	23
Clamp Meter selection guide	24
381/365 Clamp Meters	25
370 Series Clamp Meters	26
320 Series / 902 Clamp Meters	27
353/355 AC/DC Clamp Meters	28
360 Current Leakage Clamp Meter	29
T100 Series Voltage/Continuity Testers	30
T5/T5-H5-1AC Kit Electrical Testers	31
2AC/1AC-II/LVD1/LVD2 Voltage Detectors	32
9040/9062 Phase Rotation Indicators	33
2042 Cable Locator	34

Insulation Testers/Earth Ground Testers	35
Insulation Tester Selection Guide	36
1577/1587 Insulation Multimeters	37
1503/1507 Insulation Testers	38
1555/1550C Insulation Resistance Testers	39
1620 Series Earth Ground Testers	40
1621 Earth Ground Tester	41
1630 Ground Loop Tester	42

Installation Testers/Portable Appliance Testers	43
1650 Series Multifunction Installation Testers	44-45
6000 Series Portable Appliance Testers	46-47
1650/6000 Series Accessories	48

Digital Thermometers	49
Infrared Thermometer Selection Guide	50
570 Series Precision Infrared Thermometers	51
60 Series Infrared Thermometers	52
566/568 Multipurpose Thermometers	53
561 Multipurpose Thermometer	54
50 Series II Thermometers	55
1523/1524 Reference Thermometers	56
1551A/1552A Ex "Stik" Thermometers	57

Thermal Imagers	58
Ti Series Thermal Imagers	59
Ti32/Ti29/Ti27 Industrial Thermal Imagers	60-61
TiR32/TiR29/TiR27 Industrial Thermal Imagers for Building Diagnostics	62-63
Ti125/Ti110/Ti100 Industrial / Commercial Thermal Imagers	64-65
TiR125/TiR110/Ti100 Building Diagnostic Thermal Imagers	66-67
Ti9/Ti10/Ti25 Thermal Imagers	68-69
TiS/TiR/TiRx/TiR1 Thermal for Building Inspection	70-71
Hawk IR CRange IRWindows	72

Laser Distance Meters	73
421D/416D/411D Laser Distance Meters	74

Indoor Air Quality Tools	75
975 Air Meter	76
922 Airflow Meter	77
971 Temperature Humidity Meter	78
983 Particle Counter	79

ScopeMeter® Test Tools	80
ScopeMeter 190 Series II	81-83
ScopeMeter 120 Series	84
ScopeMeter 225C/S and general specifications	85
ScopeMeter Accessories	86

Power Quality Tools	87
Power Quality Selection Guide	88
345 Power Quality Clamp Meter	89
43B Single-phase Power Quality Analyzer	90
1710 Single-Phase Voltage Quality Recorder	91
430 II Series Three-phase Power Quality Analyzers	92-93
1735 Power Logger	94
1740 Series Power Quality Loggers	95
1750 Power Recorder	96
1760 Power Quality Recorder	97
Power Quality Current Clamp Accessories	98
Norma 4000/5000 Series	99-100

Field Calibrators	101
Field Calibrator Selection Guide	102
750 Series Documenting Process Calibrators	103
726/725/725Ex Multifunction Process Calibrators	104
724 Temperature Calibrator	105
712/714 Temperature Calibrators	106
914X/418X Drywells/IR Calibrators	107
717/718/718Ex/719 Pressure Calibrators	108
705/707/707Ex/715 Loop Calibrators	109
771/772/773 mA Clamp Meters	110
787/789 ProcessMeters	111
Field Calibrator Accessories	112

Vibration Tester	113
810 Vibration Tester	114

Radation Meter	115
481 Radation Meter	116

ATEX Certified Test Tools	117
A brief look at ATEX	118
Fluke intrinsically safe tools	119

General Accessories	120
Electronic Test Leads, Probes & Clips	121
Industrial Test Leads, Probes & Clips	122-123-124
Automotive Accessories	125
Current Clamps	126-127
Temperature Accessories	128-129
Cases and Holsters	130-131
Software and Other Accessories	132
Other Accessories	133
Fuse and Warranty Information	134

Fluke Web and Electronic Newsletter

FLUKE®

Fluke web

Complete information

The most complete and in-depth resource for information on Fluke's products and services including:

- Product information
- Solution Centers
- Interactive selection guides
- Virtual product demonstrations
- Extended specifications
- Application notes
- Product manuals
- Service information
- Promotions
- Prices
- Where to buy
- Distributor and sales office locations

Find information fast

To quickly find more information on Fluke products, use the "Search by model" box in the top left corner of our web pages. All you have to do is type in the model number.

UK: www.fluke.co.uk

IE: www.fluke.ie

Worldwide: www.fluke.com



Fluke web sites are available in all countries around the world and in 18 different languages.



Electronic Newsletter

E-Test-it! is Fluke's regular news publication for professional test tool users. It is electronically available 6 times per year. You will be the first to hear about:

- New Fluke products
- The latest actions and promotions from Fluke
- How to get more out of Fluke tools
- How to use Fluke tools better in your application
- Exclusive offers, promotions and discounts on Fluke Merchandizing
- Exclusive offers on Fluke ex-demo equipment

E-Test-it! is free of charge. If at any point in time you do not want to receive E-Test-it! anymore, you can unsubscribe with a simple mouse click. E-Test-it! is small in size (on average about 12 KB) and does not fill up your mailbox or take long to download.

Try it now and sign-up for your FREE e-Test-it! subscription. Go to the Fluke web site and fill in the on-line subscription form.

New from Fluke



Fluke 190 Series II Scopemeter

For the first time, plant maintenance engineers and technicians can take a high-performance four-channel scope into the harsh world of industrial electronics.

See page 81-83.

Fluke TiS Thermal Imaging Scanner

Fluke proudly introduces an entry level thermal imager for quick, easy, and accurate problem identification and troubleshooting designed specifically for the building inspection professional.

See page 70 and 71.



Fluke 1654B Multifunction Installation Tester

The new 1654B Installation Tester builds upon the rugged reputation of the earlier 1650 Series, only it's re-designed to meet your need for more productive test tools.

See page 44 and 45.

Fluke 365 Detachable Jaw True-rms AC/DC Clamp Meter

The Fluke 365 is a new, innovative Fluke clamp meter, offering a thin, small jaw design that makes it easy to get around tightly packed wires.

See page 25.



Fluke 750 series Documenting Process Calibrators

Fluke 750 series process calibrators can help you get the job done faster. It does so many different tasks, so quickly and so well, it's the only process calibrator you need to carry.

See page 103.

Fluke 370 series Clamp Meters

With this new family of clamp meters, Fluke provides a range of state-of-the-art capabilities to meet users' most demanding requirements for flexibility, safety and performance.

See page 26.



Fluke 381 Remote Display True-rms AC/DC ClampMeter with iFlex

The new Fluke 381 does everything you would expect from a clamp meter, and then lets you remove the display for even more flexibility.

See page 25.

New from Fluke



Fluke Ti27/Ti29 Thermal Imagers

Designed for industrial and commercial environments, the Fluke P3 series of thermal imagers deliver superior image quality, versatility, and affordability without compromise.

See page 60-63.

Ti125/Ti110/Ti100/TiR125/TiR110 Thermal Imagers

Fluke proudly introduces five new thermal imagers specifically designed to help you do more in less time, while being at home in the harshest of environments. A project that might normally take an hour can now be done in minutes. Our newest imagers are the lightest, most rugged, easiest-to-use professional imagers you can buy.

See page 64-67.



Fluke 430 Series II Three-Phase Power Quality and Energy Analyzers

The new Fluke 434, 435 and 437 Series II models help locate, predict, prevent, and troubleshoot power quality problems in three-phase and single-phase power distribution systems.

See page 92-93.

1551A Ex and 1552A Ex “Stik” Thermometer

Accurate and repeatable to ± 0.05 °C over its full range, the 1551A/1552A “Stik” Thermometer is the new “gold standard” of industrial temperature calibration.

See page 57.



Fluke 1555/1550C Insulation Resistance Testers

The new 1555 and redesigned Fluke 1550C insulation resistance testers offer digital insulation testing up to 10kV, making them ideal for testing a wide range of high voltage equipment including switchgear, motors, generators and cables.

See page 39.

TL175 Twistguard™ Test Leads

The new Fluke TL175 TwistGuard™ Test Leads are the innovative test leads with adjustable length test tips for use in different measurement environments.

See page 124.



Fluke Combo Kits

Buy a Combo Kit and save



- Fluke 117/322 Kit
Electrician's Combo Kit**
- Fluke 117 True RMS Multimeter
 - Fluke 322 Clamp Meter
 - Silicon test lead set
 - TPAK Magnetic Hanger
 - C115 Deluxe carrying case with shoulder strap



- Fluke 179/MAG2 Kit
Industrial Combo Kit**
- Fluke 179 True RMS Multimeter
 - TL224 SureGrip™ Silicone Test Lead Set
 - AC220 SureGrip™ Alligator Clip Set
 - TP74 lantern tip test probe set
 - TPAK Magnetic Hanger
 - 80BK-A Integrated DMM Temperature Probe
 - C35 Soft Meter Case
 - + Maglite flashlight



- Fluke 179/TPAK
179/ToolPak Combo Kit**
- Fluke 179 True RMS Multimeter
 - TPAK ToolPak Meter Hanging Kit



- Fluke 179/EDA2 Kit
Electronics Combo Kit**
- Fluke 179 True RMS Multimeter
 - TL224 SureGrip™ Silicone Test Lead Set
 - TL910 Electronic Test Probe Set
 - AC280 SureGrip™ Hook Clip Set
 - TPAK Magnetic Hanger
 - 80BK-A Integrated DMM Temperature Probe
 - C35 Soft Meter Case



- Fluke 179/61 Kit
Multimeter and Infrared Thermometer Combo Kit**
- Fluke 179 True RMS Multimeter
 - Fluke 61 Infrared Thermometer
 - C550 Hard Meter and Accessory Case



- Fluke 87V/E2
Industrial Electrician
Combo Kit**
- Fluke 87V True RMS Multimeter
 - TL224 SureGrip™ Silicone Test Lead Set
 - TP38 Slim Reach Test Probe Set (insulated)
 - AC220 SureGrip™ Alligator Clip Set
 - TPAK Magnetic Hanger
 - 80BK-A Integrated DMM Temperature Probe
 - C35 Soft Meter Case



- Fluke 87V/i410
Combo Kit for Industrial
Applications**
- 87V Industrial Multimeter
 - TL75 Test Leads
 - AC172 Alligator Clips
 - i410 400A AC/DC Current Clamp
 - 80BK-A Temperature Probe
 - C115 Soft Carrying Case

(Not available in all countries)

Ordering Information

- Fluke 117/322 Kit
- Fluke 179/TPAK
- Fluke 179/61 Kit
- Fluke 179/MAG2 Kit
- Fluke 179/EDA2 Kit
- Fluke 87V/E2
- Fluke 87V/i410

Fluke Combo Kits

Buy a Combo Kit and save



Fluke 287/FVF FlukeView Forms Combo Kit

- Fluke 287 True RMS Electronic Logging Multimeter with TrendCapture
- FVF-SC2 FlukeView Forms Software and cable
- 80BK-A Thermocouple Probe
- CAT III 1000 V 10 A Modular Test Leads (red, black)
- CAT II 300 V 5 A Alligator Clips (red, black)
- C280 Soft Case for meter protection and accessory storage

Fluke 289/FVF Industrial Logging Multimeter and Software Combo Kit

- Fluke 289 True-RMS Multimeter
- FVF-SC2 FlukeView Forms Software and cable
- Silicon Test Lead Set
- AC172 Alligator Clips
- 80BK-A Integrated DMM Temperature Probe
- TPAK Magnetic Meter Hanger for hands-free operation
- C280 Soft Case for meter protection and accessory storage

Fluke 1587/ET Advanced Electrical Troubleshooting Kit

- Fluke 1587 Insulation Multimeter
- Fluke 62 Mini Infrared Thermometer
- I400 Current Clamp



Fluke 1587/MDT

Fluke 1587/MDT Advanced Motor & Drive Troubleshooting Kit

- Fluke 1587 Insulation Multimeter
- Fluke 9040 Phase Rotation Indicator
- I400 Current Clamp



Fluke T5-H5-1AC Kit

- Fluke T5-1000 Electrical Tester
- H5 Holster
- 1AC-II Volt Alert



Fluke T5-600/62/IAC-E Kit

- Fluke T5-600 Electrical Tester
- Fluke 62 Mini IR Thermometer
- Fluke 1AC-II Volt Alert
- C115 Soft Meter Case



Fluke 62/322/1AC Kit

- Fluke 62 Mini IR Thermometer
- Fluke 322 Clamp Meter
- Fluke 1AC-II Volt Alert



Fluke 411D/62 Kit

- Fluke 411D Laser Distance Meter
- Fluke 62 Mini IR Thermometer
- Soft case for each model

Ordering Information

Fluke 287/FVF
 Fluke 289/FVF
 Fluke 1587/ET
 Fluke 1587/MDT
 Fluke T5-H5-1AC Kit
 Fluke T5-600/62/IAC-E Kit
 Fluke 62/322/1AC Kit
 Fluke 411D/62 Kit

Application/ background articles

As part of our commitment to supporting you in your work we do more than just design and manufacture rugged and versatile test tools: we also provide application notes which all can be downloaded from our web site. Furthermore check out our “total solutions” campaigns on the website. In addition to inspection tips and helpful application information, these campaigns also offer advice on picking the right tool for the job.



Let Fluke After Sales Service help you further

Did you know that the Fluke after sales service team can offer you much more than just repairing and calibrating your instrument when it is needed? Across our whole Fluke European service organization we have a vast range of capabilities, which can be utilized via your local service centre. Behind the scenes Fluke draws on the expertise of over 150 service staff that are focused on offering only the best and most comprehensive after sales service.



So why should you use Fluke service?

- Original manufacturers' parts used
- All instruments reviewed for latest updates
- Repair warranty that covers whole unit
- In depth product knowledge
- Accredited calibrations available
- Traceable calibrations available on all products
- Full check of unit during verification cycle
- Full safety test on mains powered units

What other instruments can we help you with?

We also offer a range of calibrations and repairs on other manufacturer's equipment upon request. Manufacturers such as:

- Tektronix
- Agilent
- Bruel & Kjaer
- Philips
- Megger
- Seaward
- Kewtech
- Lecroy
- Hioki
- Yokogawa
- Druck
- Iwatzu
- plus many more ...

What other value added services do we offer?

- Gold Support for Fluke Networks
- Gold CarePlans for calibration products
- A full range of maintenance contracts
- Extended warranty programs
- Instrument upgrades
- Option retrofits
- Asset management
- Calibration reminders

What services do we offer you?

- 5 day repairs on all current products
- 5 days or less on all calibrations (excl. repairs)
- 3 days for all Gold CarePlan calibrations
- 1-2 days on all Networks Gold calibration
- Pick up services where available



On-Line booking in system

Why not use our On-Line booking in system where you can book your unit in, get pricing and receive a RMA number for a smooth return.

www.fluke.com/servicerma

Fluke service centres handle a wide range of equipment.

As part of Fluke's continuing focus on improving our service to our customer we now offer a comprehensive range of repairs and calibrations on a vast range of equipment.

Fluke manufactures equipments such as:

Fluke Brands	Instrument Types
Fluke	Digital Multimeters
Hart Scientific	Electrical Standards
Fluke Networks	Biomedical Equipment
Fluke Biomedical	Data Loggers
Raytek	Thermal Imagers
Reliable Power Meters	Thermometers
Robin	Pressure
LEM Instruments	Function Generators
BEHA	Oscilloscopes
Norma	Installation Testers
Wavetek/Datron	PAT Testers
Metron	Clamp Meters
DHI	Power Analyzers
Comark	EX meters
	Plus many more



Contact Information

	Eindhoven	Norwich	Cologne
Telephone	+31 (0)40 267 5300	+44 (0)1603 256620	+49 (0)69 2222 20210
Telefax	+31 (0)40 267 5321	+44 (0)1603 256688	+49 (0)69 2222 20211
Email	servicedesk@fluke.nl	ukservicedesk@fluke.com	servicedeskgermany@fluke.com
Address	Science Park 5108 Eindhoven 5692 EC Son Netherlands	52 Hurricane Way Norwich Norfolk NR6 6JB United Kingdom	Heinrich-Pesch-Str. 9-11 50739 Köln Germany

Fluke: Where safety is built in



As distribution systems and loads become more complex, the possibilities of transient overvoltages increase. Motors, capacitors and power conversion equipment such as variable speed drives can be prime generators of spikes. Lightning strikes on outdoor transmission lines also cause extremely hazardous high-energy transients. If you're taking measurements on electrical systems, these transients are "invisible" and largely unavoidable hazards. They occur regularly on low-voltage power circuits, and can reach peak values in the many thousands of volts. To protect you against transients, safety must be built into the test equipment.

Who Develops Safety Standards?

The IEC (International Electrotechnical Commission) develops international general standards for safety of electrical equipment for measurement, control and laboratory use. IEC61010-1 is used as the basis for the following national standards:

- US ANSI/ISA-S82.01-94
- Canada CAN C22.2 No.1010.1-92
- Europe EN61010-1:2001

Overvoltage Installation Categories

IEC61010-1 specifies categories of overvoltage based on the distance the piece of equipment is from the power source (see Fig. 1 and Table 1) and the natural damping of transient energy that occurs in an electrical distribution system. Higher categories are closer to the power source and require more protection. Within each installation category there are voltage classifications. It is the combination of installation category and voltage classification which determines the maximum transient withstand capability of the instrument.

of the 12 Ω test source for CAT II. The CAT III 600 V meter clearly offers superior transient protection compared to the CAT II 1000 V meter, even though its so-called "voltage rating" could be perceived as being lower. See Table 2.

Independent testing is the key to safety compliance

How can you tell if you're getting a genuine CAT III or CAT II meter? Unfortunately it's not always that easy. It is possible for a manufacturer to self-certify that its meter is CAT II or CAT III without any independent verification. The IEC (International Electrotechnical Commission) develops and proposes standards, but it is not responsible for enforcing the standards. Look for the symbol and listing number of an independent testing lab such as UL, CSA, VDE, TÜV or other recognized approval agency.

These symbols can only be used if the product successfully completed testing to the agency's standard, which is based on national and

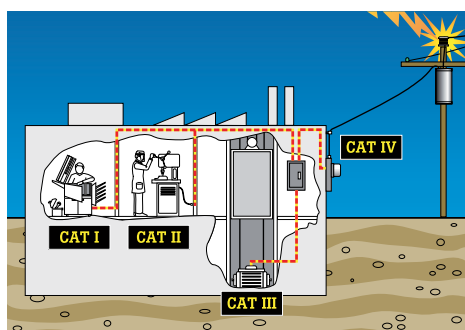

Figure 1. Understanding categories: location

IEC 61010 test procedures take into account three main criteria: steady-state voltage, peak impulse transient voltage and source impedance. These three criteria together will tell you a multimeter's true voltage withstand value.

Within a category, a higher working voltage" (steadystate voltage) is associated with a higher transient, as would be expected. For example, a CAT III 600 V meter is tested with 6000 V transients while a CAT III 1000 V meter is tested with 8000 V transients. So far, so good. What is not as obvious is the difference between the 6000 V transient for CAT III 600 V and the 6000 V transient for CAT II 1000 V. They are not the same. This is where the source impedance comes in. Ohm's Law (Amps = Volts/Ohms) tells us that the 2 Ω test source for CAT III has six times the current



international standards. UL 3111, for example, is based on EN61010-1. In an imperfect world, this is the closest you can come to ensuring that the meter you choose was actually tested for safety.

Table 1

Overvoltage category	In brief	Examples
CAT IV	Three-phase at utility connection, any outdoor conductors	<ul style="list-style-type: none"> • Refers to the "origin of installation"; i.e., where low-voltage connection is made to utility power. • Electricity meters, primary overcurrent protection equipment. • Outside and service entrance, service drop from pole to building, run between meter and panel. • Overhead line to detached building, underground line to well pump.
CAT III	Three-phase distribution, including single-phase commercial lighting	<ul style="list-style-type: none"> • Equipment in fixed installations, such as switchgear and polyphase motors. • Bus and feeder in industrial plants. • Feeders and short branch circuits, distribution panel devices. • Lighting systems in larger buildings. • Appliance outlets with short connections to service entrance.
CAT II	Single-phase receptable connected loads	<ul style="list-style-type: none"> • Appliance, portable tools, and other household and similar loads. • Outlet and long branch circuits. • Outlets at more than 10 meters (30 feet) from CAT III source. • Outlets at more than 20 meters (60 feet) from CAT IV source.
CAT I	Electronic	<ul style="list-style-type: none"> • Protected electronic equipment. • Equipment connected to (source) circuits in which measures are taken to limit transient overvoltages to an appropriately low level. • Any high-voltage, low-energy source derived from a high-winding resistance transformer, such as the high-voltage section of a copier.

Fluke: Where safety is built in

Safety is everyone's responsibility but ultimately it is in your hands. No tool by itself can guarantee your safety when working with electricity. It's the combination of the right tools and safe work practices that gives you maximum protection. Here are a few tips to help you in your work:

Make sure you always comply with (local) regulations.

Work on de-energized circuits whenever possible.

Use proper lock-out/tag-out procedures. If these procedures are not in place or enforced, assume that the circuit is live.

Use protective gear when working on live circuits:

- Use insulated tools
- Wear safety glasses or a face shield
- Wear insulated gloves, remove watches or jewelry
- Stand on an insulated mat
- Wear flame resistant clothing, not ordinary work clothes



Use protective equipment such as safety glasses and insulated gloves



Use meters with these markings: 1000 V CAT III or 600 V CAT IV

Select the right test tool:

- Choose a test tool rated to the highest category and voltage for which it could possibly be used (most often 600 or 1000 volt CAT III and/or 600 volt CAT IV).
- Look for the category and voltage marking near the recessed input connectors of your test tool and a "double insulated" symbol on the back.
- Verify your test tool has been tested and certified by two or more independent testing laboratories, such as UL in the United States and VDE or TÜV in Europe by looking for the symbols of these agencies on (the back of) your test tool.
- Make sure that the test tool is made of a high-quality, durable non-conductive material.
- Check the manual to verify that the ohms, continuity and capacitance circuits are protected to the same level as the voltage test circuit, to reduce hazards when the test tool is used incorrectly in ohms, continuity or capacitance mode (if applicable).
- Verify that the test tool has internal protection to prevent instrument damage when voltage is incorrectly applied to an amperage measurement function (if applicable).
- Make sure that the amperage and voltage of your test tool's fuses meets specifications. Fuse voltage must be as high or higher than the test tool's voltage rating.
- Be sure to use test leads that have:
 - Shrouded connectors
 - Finger guards and a non-slip surface
 - Category ratings that equal or exceed those of the test tool
 - Double insulation (look for the symbol)
 - A minimum of exposed metal on the probe tips

Inspect and test your test tool:

- Check for a broken case, worn test leads or a faded display.
- Make sure the batteries still deliver sufficient power to get reliable readings. Many test tools have a low battery indicator on the display.
- Check the test leads resistance for internal breaks while moving the leads around (good leads measure 0.1-0.3 Ohm).
- Use the meter's own test capability to ensure that the fuses are in place and working right (see manual for details).

Apply the appropriate working practices when measuring on live circuits:

- Hook on the ground clip first, then make contact with the hot lead. Remove the hot lead first, the ground lead last.
- Use the three-point test method, especially when checking to see if a circuit is dead. First test a known live circuit. Second, test the target circuit. Third, test the live circuit again. This verifies that your test tool worked properly before and after the measurement.
- Hang or rest the test tool if possible. Try to avoid holding it in your hands, to minimize personal exposure to the effects of transients.
- Use the old electrician's trick of keeping one hand in your pocket. This lessens the change of a closed circuit across your chest and through your heart.

Table 2

Overvoltage Installation Category	Working Voltage (DC or AC RMS to ground)	Peak Impulse Transient (20 repetitions)	Test Source (Ω = V/A)
CAT I	600 V	2500 V	30 Ohm source
CAT I	1000 V	4000 V	30 Ohm source
CAT II	600 V	4000 V	12 Ohm source
CAT II	1000 V	6000 V	12 Ohm source
CAT III	600 V	6000 V	2 Ohm source
CAT III	1000 V	8000 V	2 Ohm source
CAT IV	600 V	8000 V	2 Ohm source

Transient test values for overvoltage installation categories. (50 V/150 V/300 V values not included)

Fluke Solution

Fluke total solutions campaigns



Fluke has launched a total solutions campaign focused on all our products and the benefits for you. Discover how Fluke tools can help you make or save money. You can find a wide range of useful background information, www.flukesolution.co.uk

Plant Maintenance

Focus on motors and drives, energy saving and process trouble shooting, where Fluke's Test & Measurement tools can help you make the difference. Learn more about our latest developments in for example inspecting motors and drives.

Thermography

Focus on the user experience of our Thermal Imagers and experience the wide-ranging benefits of thermal imaging in everyday on-the-job situations. See what Fluke Thermography has to offer to make your work easier.

Energy

Focus on energy saving benefits in the industrial maintenance market. Fluke Test & Measurement tools help you to detect problems and/or monitoring situations –prevention- before they become critical. Learn how we can help you make or save money in your plant or industry.

www.flukesolution.co.uk

Visit the full portal to get all your troubleshooting solutions from one source. Every Fluke tool is built around one idea... You!

Digital Multimeters

Safety, quality and performance: three words that sum up the benefits of our extensive range of digital multimeters. Designed to help you do your job faster, more efficiently and with greater accuracy, there is a model for every budget and application. Choose from handheld troubleshooters to ultra smart instruments packed with features, including the ability to log and graph data, as well as high-precision bench units.



DMM Selection guide

	Highest accuracy	Remote display	High-end Industrial	Industrial maintenance and field service	Electrical	HVAC/R	Field Service	Basic Electrical	Heavy duty (IPE7)	General Purpose	Auto-motive	Loop calibration	Insulation test
Basic features	289	287	83V	179	177	116	115	114	271I	77V	88V	789	1577
Counts	50000	50000	6000	6000	6000	6000	6000	6000	20000	6000	20000	4000	6000
True RMS readings	AC+DC	AC+DC	AC	AC	AC	AC	AC	AC	AC	AC	AC	AC	AC
Basic DC accuracy	0.025%	0.025%	0.1%	0.09%	0.15%	0.5%	0.5%	0.5%	0.1%	0.3%	0.1%	0.1%	0.09%
Wide bandwidth	100 kHz	100 kHz	5 kHz						50 kHz				
Auto/manual ranging	●/●	●/●	●/●	●/●	●/●	●/●	●/●	●/●	●/●	●/●	●/●	●/●	●/●
Measurements													
Voltage AC/DC	1000V	1000V	1000V	1000V	1000V	600V	600V	600V	1000V	1000V	1000V	1000V	1000V
Current AC/DC	10A	10A	10A	10A	10A	200 μA	10A	10A	10A	10A	10A	1A	400 mA
Resistance	500 MΩ	500 MΩ	50 MΩ	50 MΩ	50 MΩ	40 MΩ	40 MΩ	60 kΩ	50 MΩ	50 MΩ	50 MΩ	40 MΩ	50 MΩ
Frequency	1 MHz	50 kHz	200 kHz	100 kHz	100 kHz	50 kHz	50 kHz		200 kHz	100 kHz	200 kHz	20 kHz	100 kHz
Capacitance	100 mF	10 mF	10 mF	10 mF	10 mF	10 mF	10 mF	10 mF	10 mF	10 mF	10 mF	10 mF	10 mF
Temperature	+1350°C	+1350°C	+400°C	+400°C		+400°C			+1090°C		+1090°C		+500°C
dB	60 dB	60 dB											
Conductance	50 nS	50 nS	60 nS						60 nS		60 nS		
Duty cycle/pulse width	●/●	●/●	●/●						●/●		●/●		
Continuity with beeper/Diode test	●/●	●/●	●/●	●/●	●/●	●/●	●/●	●/●	●/●	●/●	●/●	●/●	●/●
4-20mA loop current as % readout													
Motor drive measurement	●												●
RPM/Dwell													
VoltAlert™, Non-contact voltage detection					●								
LoZ: low input impedance	●				●			●					
VCHEK™ LoZ													
Microamps	●	●											
Insulation test													●
Number of insulation test ranges													5
Display													2
Dual display	●	●											
Analog bargraph	●	●											
Backlight	●	●											
Remote display	●	●											
Data storage and exchange													
Min-Max recording/with time stamp	●/●	●	●/●	●/●	●/●	●/●	●/●	●/●	●/●	●/●	●/●	●/●	●/●
Fast Min-Max	250 μs	250 μs	250 μs						250 μs		250 μs		
Display Hold/Auto (Touch) Hold	●/●	●	●/●	●/●	●/●	●/●	●/●	●/●	●/●	●/●	●/●	●/●	●/●
Relative	●	●	●										
Stand alone logging/TrendCapture	●/●	●/●											
USB interface/RS232 interface	●/●	●/●											
Readings memories	10000	10000											
Other features													
Source 4-20mA loop current/24V loop supply													
Automatic selection, AC/DC volts					●								
Real time clock	●	●											
Smoothing				●									●
Integrated holster				●									
Removable holster	●	●		●									
Closed case calibration	●	●		●									
Separate battery/fuse access	●/●	●/●	●/●	●/●	●/●	●/●	●/●	●/●	●/●	●/●	●/●	●/●	●/●
Completely sealed/watertight	●	●		●									
Automatic power off	●	●		●									
Low battery indication	●	●		●									
Warranty and safety													
Lifetime warranty/warranty (years)	●	●	3	●	●	3	3	3	●	●	●	3	3
Input alert	●	●											
Dangerous voltage indication													
EN61010-1 CAT III	1000V	1000V	1000V	1000V	1000V	600V	600V	600V	1000V	1000V	1000V	1000V	1000V
EN61010-1 CAT IV	600V	600V	600V	600V	600V	600V	600V	600V	600V	600V	600V	600V	600V
See catalog page	13	13	14	16	16	17	17	17	18	19	20	111	37

280 Series Digital Multimeters



Fluke 289



Fluke 287

Advanced diagnostic and logging functionality for maximizing productivity

Replacing the popular 180 Series, the Fluke 289 and Fluke 287 represent the next generation of high-performance industrial logging multimeters, including higher accuracy and greater troubleshooting convenience than ever before. With the ability to log data and review it graphically on the large display, you can solve problems faster and help minimize downtime, while working at several locations.

- Large 50,000 count 320 x 240 (1/4 VGA) dot matrix display

- Logging function with TrendCapture for easy review of logged data
- Multiple readings per display provide more information at a glance
- "I"-info button for convenient on-board help
- PC interface for easy data transfer

In addition, the Fluke 289 provides:

- Lo Pass filter for motor drive measurements
- LoZ – Low impedance function prevents false "ghost voltage" readings
- 50 Ω range for motor winding and low ohm measurements

Features

	287	289
True-RMS measurements	AC, AC+DC	AC, AC+DC
Bandwidth (voltage/current)	100 kHz / 100 kHz	100 kHz / 100 kHz
Digital display counts (default/selectable)	50,000 / 50,000	50,000 / 50,000
Logging function with TrendCapture	●	●
Records events and trends	●	●
Internal memory	Up to 180 h	Up to 180 h
Saves measurements	●	●
Optical USB PC communications interface	●	●
Low input impedance function (LoZ)	●	●
Motor winding and low ohm measurement range		50 Ω
Low pass filter		●
Field upgradeable/expandable meter	●	●
Navigation keys	●	●
F1-F4 soft keys/user function menus	●	●
I-info button/on board help screens	●	●
Multilingual interface	●	●
Saves preferred measurement setups	●	●
Current measurement: 20 A (30 seconds momentary; 10 A continuous)	●	●
Peak capture (records transients as fast as 250 μs)	●	●
Continuity measurement	●	●
Min/Max/Average with Time Stamp (records signal fluctuations)	●	●
IP Rating 54	●	●



Precise performance



View logged data graphically on screen



Specifications

(Check the Fluke web for detailed specifications)

Functions	Maximum	Max. resolution	287 and 289**
Voltage DC	1000 V	1 μV	±(0.025% + 5)
Voltage AC	1000 V	1 μV	±(0.4% + 40)
Current DC	10 A	0.01 μA	±(0.15% + 2)
Current AC	10 A	0.01 μA	±(0.7% + 5)
Temperature	-200 °C to 1350 °C	0.1 °C	±(1.0% + 1 °C)
Resistance	500 MΩ	0.01 Ω	±(0.05% + 2)
Conductance	50 nS	0.01 nS	±(1.0% + 10)
Capacitance	100 mF	0.001 nF	±(1.0% + 5)
Frequency	1 MHz	0.01 Hz	±(0.005% + 1)

Accuracies are best accuracies for each function.
** 287 and 289 accuracy and resolution are stated for 50,000 counts

Battery life: 50 hours minimum,
180 hours in logging mode
Size (HxWxD): 222 mm x 102 mm x 60 mm

Weight: 0,871 kg
Lifetime warranty

Included Accessories

TL175 test leads, AC172 alligator clips, probe holder, 6 AA batteries (installed), user manual, Calibration Certificate Sheet.

Ordering Information

- Fluke 287 True-RMS Electronic logging multimeter with TrendCapture
- Fluke 289 True-RMS Industrial logging multimeter with TrendCapture
- Fluke 289/FVF Industrial logging multimeter and Software Combo Kit (see page 5)
- Fluke 287/FVF FlukeView Forms Combo Kit (see page 5)
- FVF-SC2 FlukeView Forms software including IR/USB cable

Recommended Accessories



TLK289
See page 123

TL910
See page 121

TLK287
See page 121

TPAK
See page 132

C280
See page 130

233 Remote Display Multimeter



Fluke 233



On all inputs



Ultimate flexibility with removable display

The Fluke 233 remote display digital multimeter allows you to be in two places at once. The removable display solves the problems of holding both the meter and the test leads to make a measurement, making measurements in hard-to-reach places, and making measurements in machines or panels that are physically separated from a limit

switch or an isolator switch. Wireless technology allows the display to be carried up to 10 meters away from the point of measurement. The Fluke 233 is also designed to work in areas where the operator can't be close to the active measurement point, like clean rooms or hazardous areas.

Features

	233
Removable magnetic display	•
True-RMS measurement	•
Digital display counts	6000
Display backlight	•
Built in thermometer	•
Resistance, continuity and diode test	•
Min/Max and average recording	•
Auto power off maximizes battery life	•
Radio transmitter automatically turns off when the display is connected to the meter	•
Use as conventional multimeter when the display is connected	•
Safety rating	CAT IV 600 V / CAT III 1000 V
Auto and manual ranging	•
Display Hold and AutoHOLD®	•
Unsafe voltage alert warns for voltages above 30V	•
2 Low batteries indication	•
Ergonomic case with integrated holster	•
Selectable sleep mode preserves battery life	•

Specifications

Functions	Fluke 233		
	Maximum	Max. Resolution	Accuracy
Voltage DC	1000 V	0.1 mV	±(0.25% + 2)
Voltage AC	1000 V	0.1 mV	±(1.0% + 3)
Current DC	10 A	1 mA	±(1.0% + 3)
Current AC	10 A	1 mA	±(1.5% + 3)
Resistance	40 MΩ	0.1 Ω	±(0.9% + 1)
Capacitance	9999 μF	1 nF	±(1.9% + 2)
Frequency	50.00 kHz	0.01 Hz	±(0.1% + 2)
Temperature	-40 °C to +400 °C	0.1 °C	±(1% + 10)
Wireless frequency: 2.4 GHz ISM Band 10 meter range			

Accuracies are best accuracies for each function

Included Accessories

Test leads with 4mm lantern tips, AC 172 alligator clips, 80BK-A temperature probe, CD-ROM, AA batteries and user manual.

Ordering Information

Fluke 233 Remote Display Multimeter

Battery Life: AA alkaline (3 for main body, 2 for display), 400 hrs typical
Size (HxWxD): 193 x 93 x 53 mm

Weight: 0.6 kg
Three year warranty

Recommended Accessories



80AK-A
See page 128



80PK-9
See page 128



i410
See page 127



Tpak
See page 132



C35
See page 130

80 Series V Digital Multimeters

FLUKE®



Fluke 87V



Fluke 83V



83V/87V



On all inputs



Fluke 87V Ex



True RMS



not 87V Ex

Included Accessories

TL175 test leads, AC172 alligator clips, yellow holster (H80M excl. TPAK), 80BK temperature probe (87V only), 9 V battery (installed), CD-ROM (user's manual and technical notes) and operator's guide.

Ordering Information

Fluke 83V Multimeter
 Fluke 87V True RMS Multimeter
 Fluke 87V Ex Intrinsically safe True RMS multimeter
 Fluke 87V/E2 Industrial Electrician Combo Kit
 See page 4

Performance and accuracy for maximum industrial productivity

The Fluke 80 Series V have improved measurement functions, troubleshooting features, resolution and accuracy to solve more problems on motor drives, in plant automation, power distribution, and electro-mechanical equipment.

The Fluke 87V has a unique function for accurate voltage and frequency measurements on adjustable speed motor drives and other electrically noisy equipment. A built-in thermometer conveniently allows you to take temperature readings without having to carry a separate instrument. For 87V Ex see also page 118 and 119.

Features

	83V	87V / 87V Ex
True-RMS voltage and current for accurate measurements on non linear signals Bandwidth (voltage/current)		●
Digital display counts (default/selectable)	6000	20000 / 6000
Selectable filter for accurate voltage and frequency measurements on motor drives		●
Large display with analog bargraph and 2 level bright white backlight	●	●
Auto and manual ranging for maximum flexibility	●	●
Built-in thermometer lets you carry one less tool		●
Peak capture to record transients as fast as 250 μs		●
Relative mode to remove test lead resistance from low ohms measurements	●	●
Min-Max-Average recording with Min/Max Alert to capture variations automatically	●	●
AutoHOLD® to capture stable readings avoiding noisy signals	●	●
Audible continuity, diode test and duty cycle	●	●
Input Alert	●	●
"Classic" design with new removable holster with built in test lead and probe storage	●	●
Improved selectable sleep mode for long battery life	●	●
Easy battery exchange without opening the complete case	●	●
ATEX safety rating (EX) II 2 G Ex ia IIC T4		87V Ex

Specifications

(Check the Fluke web for detailed specifications)

Functions	Maximum Range	83V		87V/87V Ex*	
		Max. resolution	Accuracy	Max. resolution	Accuracy
Voltage DC	1000 V	0.1 mV	±(0.1%+1)	10 μV	±(0.05%+1)
Voltage AC	1000 V	0.1 mV	±(0.5%+2)	10 μV	±(0.7%+2)
Current DC	10 A **	0.1 μA	±(0.4%+2)	0.01 μA	±(0.2%+2)
Current AC	10 A **	0.1 μA	±(1.2%+2)	0.01 μA	±(1.0%+2)
Resistance	50 MΩ	0.1 Ω	±(0.4%+1)	0.01 Ω	±(0.2%+1)
Conductance	60 nS	0.01 nS	±(1.0%+10)	0.001 nS	±(1.0%+10)
Capacitance	9999 μF	0.01 nF	±(1.0%+2)	0.01 nF	±(1.0%+2)
Frequency	> 200 kHz	0.01 Hz	±(0.005%+1)	0.01 Hz	±(0.005%+1)
Temperature	-200 to 1090 °C	-	-	0.1 °C	1.0%
80BK temperature probe	-40 to 260 °C	-	-	-	2.2 °C or 2%

Accuracies are best accuracies for each function.
 * 87V accuracy is stated for 6000 counts and resolution for 20000 counts
 ** 20 A up to 30 seconds

Battery Life: Over 400 hours typical (alkaline).
Size (HxWxD): 200 mm x 95 mm x 48 mm

Weight: 0.6 kg
83V/87V: Lifetime Warranty
87V Ex: One Year Warranty

Recommended Accessories

(Not for hazardous zones)



C25
See page 130



TL238
See page 122



i410/i1010
See page 127



TPAK
See page 132



L215
See page 123

170 Series Digital Multimeters

Versatile meters for field service or bench repair

These meters have the features needed to find most electrical, electro-mechanical and heating and ventilation problems.

They are simple to use and have significant improvements over Fluke's original 70 Series like True-RMS, more measurement functions, conformance to the latest safety standards, and a much larger display that's easier to view.



Fluke 179



Fluke 177



Fluke 175



On all inputs



True RMS

Included Accessories

Test leads with 4 mm lantern tips, installed 9V battery and users manual. The 179 also includes the 80BK temperature probe.

Ordering Information

Fluke 175	True RMS Multimeter
Fluke 177	True RMS Multimeter
Fluke 179	True RMS Multimeter
Fluke 179/EDA2 Kit	Electronics Combo Kit
Fluke 179/MAG2 Kit	Industrial Combo Kit
	See page 4

Features

	175	177	179
True-RMS measurements	AC	AC	AC
Digital display counts, updates 4 times per second	6000	6000	6000
Display backlight		●	●
Analog bargraph / 33 segments, updates 40 times per second	●	●	●
Auto and Manual ranging	●	●	●
Display Hold and AutoHOLD®	●	●	●
Min-Max-Average recording mode with Min/Max Alert	●	●	●
Temperature readings (bead thermocouple probe included)			●
Smoothing mode allows filtering of rapidly changing inputs	●	●	●
Audible continuity and diode test	●	●	●
Test lead alert	●	●	●
Unsafe voltage alert warns for voltages above 30V	●	●	●
Low battery indication	●	●	●
Ergonomic case with integrated holster	●	●	●
Easy battery and fuse exchange without opening the complete case	●	●	●
Selectable sleep mode preserves battery life	●	●	●

Specifications

(Check the Fluke web for detailed specifications)

Functions	Maximum	Max. resolution	175	177	179
Voltage DC	1000 V	0.1 mV	±(0.15%+2)	±(0.09%+2)	±(0.09%+2)
Voltage AC	1000 V	0.1 mV	±(1.0%+3)	±(1.0%+3)	±(1.0%+3)
Current DC	10 A	0.01 mA	±(1.0%+3)	±(1.0%+3)	±(1.0%+3)
Current AC	10 A	0.01 mA	±(1.5%+3)	±(1.5%+3)	±(1.5%+3)
Resistance	50 MΩ	0.1 Ω	±(0.9%+1)	±(0.9%+1)	±(0.9%+1)
Capacitance	10000 μF	1 nF	±(1.2%+2)	±(1.2%+2)	±(1.2%+2)
Frequency	100 kHz	0.01 Hz	±(0.1%+1)	±(0.1%+1)	±(0.1%+1)
Temperature	-40 °C/+400 °C	0.1 °C			±(1.0%+10)

Accuracies are best accuracies for each function

Battery Life: Alkaline, 200 hrs typical
Size (HxWxD): 190 mm x 85 mm x 45 mm

Weight: 0.42 kg
Lifetime Warranty

Recommended Accessories



i400
See page 126



C90
See page 130



TLK-220
See page 122



SV225
See page 133



i410-i1010
See page 127

110 Series Digital Multimeters



Fluke 117



Fluke 115



Fluke 114



Fluke 116



Fluke 113



On all inputs



True RMS

Compact design for ergonomic one-handed operation

The Fluke 110 Series has five true-rms DMMs, each for specific users. The compact instruments offer convenient one-handed operation and a backlit display with large, easy-to-read digits.

Fluke 117 Electrician's Multimeter with Non-Contact Voltage

The 117 is for electricians working in commercial and non-commercial premises (like hospitals and schools). It includes extras like non-contact voltage detection for faster and safer operation.

Fluke 116 Multimeter with Temperature and Microamps

The 116 is for heating, ventilation and air conditioning (HVAC) engineers. It includes temperature measurement and microamp current ranges to quickly troubleshoot HVAC problems.

Fluke 115 Field Service Testing Multimeter

An everyday multimeter for technicians, the 115 is for electrical and electronic testing in field service, industrial, and applications where more than the basic functions simplify work.

Fluke 114 Electrical Multimeter

The 114 is for electrical troubleshooting and straightforward 'go/no-go' in residential/commercial testing. It has all the basic functions plus a special feature to prevent false readings caused by ghost voltage.

Fluke 113 Multimeter

The 113 is for basic electrical tests and repairing most electrical problems. Features include Fluke's VCHEK™, added measurement functions, backlight and conformance to the latest safety standards.

Features

	113	114	115	116	117
True RMS readings	AC	AC	AC	AC	AC
Counts	6000	6000	6000	6000	6000
Backlight	●	●	●	●	●
Analog bargraph	●	●	●	●	●
AutoVolt: Automatic AC/DC voltage selection		●		●	●
VoltAlert™, Non-contact voltage detection					●
Built-in thermometer for HVAC applications				●	
LoZ: low input impedance to prevent ghost voltage		●		●	●
VCHEK™ LoZ low impedance measurement function to simultaneously test for voltage or continuity	●				
Min/Max/Average to record signal fluctuations	●	●	●	●	●
Resistance, continuity	●	●	●	●	●
Frequency, Capacitance, Diode test	- / ● / ●		●	●	●
Microamps to test flame sensors				●	
Display hold	●	●	●	●	●
Auto/manual ranging	●	●	●	●	●
Low battery indication	●	●	●	●	●
Compact case with removable holster	●	●	●	●	●

Specifications

(Check the Fluke web for detailed specifications)

Functions	Maximum	Max. resolution	113	114	115	116	117
Voltage DC	600V	1mV	±(0.5%+2)	±(0.5%+2)	±(0.5%+2)	±(0.5%+2)	±(0.5%+2)
Voltage AC	600V	1mV		±(1.0%+3)	±(1.0%+3)	±(1.0%+3)	±(1.0%+3)
Current DC	10.00A	1mA			±(1.0%+3)		±(1.0%+3)
Current AC	10.00A	0.01A			±(1.5%+3)		±(1.5%+3)
Resistance	40MΩ (113: 60KΩ)	0.1Ω	±(0.9%+2)	±(0.9%+1)	±(0.9%+1)	±(0.9%+1)	±(0.9%+1)
Capacitance	10000µF	1nF	±(1.9%+2)		±(1.9%+2)	±(1.9%+2)	±(1.9%+2)
Frequency	50kHz	0.01Hz			±(0.1%+2)	±(0.1%+2)	±(0.1%+2)
Temperature	-40°C/+400°C	0.1°C					±(1.0%+10)
VCHEK™	600.0V AC/DC	0.1V	±(2.0%+3)				

Accuracies are best accuracies for each function

Battery type: 9 volt Alkaline, 400 hours typical **Weight:** 0.55 kg (including batteries)
Size (HxWxD): 167 mm x 84mm x 46 mm **Three Year Warranty**

Included Accessories

Test leads with 4 mm lantern tips, holster, installed 9V battery and users manual

Ordering Information

Fluke 113 True RMS Multimeter
 Fluke 114 True RMS Multimeter
 Fluke 115 True RMS Multimeter
 Fluke 116 True RMS Multimeter
 Fluke 117 True RMS Multimeter
 Fluke 117/322 Kit Electricians Combo Kit (see page 4)

Recommended Accessories



C50
See page 130



TL223-1
See page 122



MC6
See page 133



TPAK
See page 132

27II / 28II Rugged IP67 Industrial Multimeters

FLUKE®



Fluke 27 II



Fluke 28 II



On all inputs



True RMS

Designed to survive water, dust and rough handling and yet troubleshoot most electrical problems

The Fluke 27 II and 28 II digital multimeters define a new standard for operating in harsh conditions with the features and accuracy to troubleshoot most electrical problems. Both meters have IP 67 (waterproof and dustproof) rating, MSHA approvals, extended operating temperature range of -15° C to + 55°C and 95% humidity, and a 3-meter drop. They withstand hazardous 8.000 volt spikes caused by load switching and

faults on industrial circuits and complies with second edition IEC and ANSI electrical safety standards. Furthermore, the 28 II has a unique function for accurate voltage and frequency measurements on adjustable speed motor drives and other electrically noisy equipment. The new Fluke 20 series multimeters are built to work in the toughest environments.

Features

	27 II	28 II
IP 67 waterproof & dustproof protection	●	●
Withstands 3 meter drop (with holster)	●	●
True-RMS measurements		●
Digital display counts	6000	20000/6000
Bright, two-level backlight	●	●
Backlit keypad buttons	●	●
Reversible, rubber holster	●	●
Built-in thermometer		●
Resistance, continuity and diode test	●	●
Min/Max and average recording	●	●
Improved sleep mode for long battery life	●	●
Relative mode to remove test lead resistance from low ohms measurements	●	●
Auto and manual ranging	●	●
Safety rating	CAT III 1000 V CAT IV 600 V	CAT III 1000 V CAT IV 600 V

Specifications

Functions	Maximum	Max. Resolution	27 II	28 II
Voltage DC	1000 V	0.1 mV	±(0.1% + 1)	±(0.05% + 1)
Voltage AC	1000 V	0.1 mV	±(0.5% + 3)	±(0.7% + 4)
Current DC	10 A	0.1 µA	±(0.2% + 4)	±(0.2% + 4)
Current AC	10A	0.1 µA	±(1.5% + 2)	±(1.0% + 2)
Temperature	-200°C to +1090°C	0.1°C		±(1% + 10)
Resistance	50MΩ	0.1Ω	±(0.2% + 1)	
Low pass filter (Measurement on VSD's)				yes
Capacitance	9999µF	0.01nF	±(1% + 2)	
Frequency	200 kHz	0.01 Hz	0.005% + 1	
Peak transient capture				250 µS

Accuracies are best accuracies for each function

Battery Life: 3x AA alkaline, 800 hrs typical
Size (HxWxD): 198 x 100 x 63.5 mm

Weight: 0.75 kg
Lifetime Warranty

Included Accessories

TL175 Test leads, AC172 alligator clips, 80BK-A temperature probe (28 II), holster, manual, CD-ROM, three AA batteries (installed)

Ordering Information

Fluke 27 II IP 67 Industrial Multimeter
Fluke 28 II IP 67 True-RMS Industrial Multimeter

Recommended Accessories

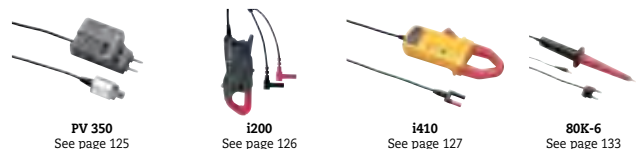

PV 350
See page 125

i200
See page 126

i410
See page 127

80K-6
See page 133

77IV Digital Multimeter

Versatile multimeter for field service or bench repair

The 77-IV digital multimeter has the features needed to repair most electrical and electronic problems. This meter is simple to use and has significant improvements over Fluke's original 70 Series with more measurement functions, conformance to the latest safety standards, and a much larger display that's easier to view.



Fluke 77 IV

Features

	77 IV
Digital display counts	6000
Large display with backlight	●
Min-Max-Average recording mode with Min/Max Alert	●
High contrast digital display with large digits	●
Analog bargraph/segments	31
Auto and Manual ranging	●
Automatic Touch Hold®	●
Audible continuity / diode test	●
Ergonomic case with integrated holster	●
Sleep Mode preserves battery life	●
EN 61010-1 safety rating	CAT IV 600 V / CAT III 1000 V

Specifications

Function	Maximum	Max. resolution	Accuracy
Voltage DC	1000 V	1 mV	±(0.3%+1)
Voltage AC	1000 V	1 mV	±(2.0%+2)
Current DC	10 A	0.01 mA	±(1.5%+2)
Current AC	10 A	0.01 mA	±(2.5%+2)
Resistance	50 MΩ	0.1 Ω	±(0.5%+1)
Capacitance	9999 μF	1 nF	±(1.2%+2)
Frequency	99.99 kHz	0.01 Hz	±(0.1%+1)

Accuracies are best accuracies for each function.

Battery Life: 400 hours typical **Weight:** 0.42 kg
Size (HxWxD): 185 mm x 90 mm x 43 mm **Lifetime Warranty**



On all inputs



Included Accessories

Test leads with 4mm lantern tips, operator's manual, 9V battery (installed)

Ordering Information

Fluke 77IV Multimeter

Recommended Accessories



i400
See page 126



C35
See page 130



Tpak
See page 132



TL225
See page 133



TLK-225
See page 123

88V Automotive Meter



Fluke 88V/A



On all inputs



Included Accessories

H80M Holster with TPAK Meter Hanging Solution, TL224 SureGrip Silicone Test Lead Set, TP74 Test Probe Set, AC285 SureGrip Large Jaw Alligator Clip Set, 80BK Integrated Temperature Probe, RPM80 Inductive Pick-up Probe, C800 Hard Case, User's Manual + Quick Reference Guide

Ordering Information

Fluke 88V/A Automotive Meter Combo Kit

The right meter for auto-electric diagnosis

Perhaps the most important tool you'll use in troubleshooting auto electrical systems is the multimeter. Basic multimeters measure voltage, current and resistance, while automotive multimeters like the Fluke 88V have features that can check frequency, duty cycle, make diode tests, and measure temperature, pressure and vacuum.

Features

	88V/A
Continuity for detecting open and shorts	●
Frequency for "pulsed-DC" and AC tests	●
Duty cycle to verify operation of feedback carburetors	●
Diode test for alternator testing	●
Built-in thermometer; thermocouple probe included	●
Min/Max/Average recording with Min/Max Alert	●
Peak capture to record transients as fast as 250 μs	●
Relative mode to remove test lead resistance from low ohms measurements	●
Millisecond pulse width measurements for fuel injectors	●
AutoHOLD® to capture stable readings	●
Large display with bright, two-level backlight	●
Magnet hanger to attach meter to the vehicle	●
RPM80 Inductive Pickup for both conventional and distributorless (DIS) ignitions	●
Hard Meter Case	●
Safety rating	CAT III 1000 V, CAT IV 600 V

Specifications

	Fluke 88V		
	Range	Resolution	Accuracy
Voltage DC	1000V	0.1mV	0.1%
Voltage AC	1000V (5 kHz)	0.1mV	0.5%
Current DC	10A	0.1μA	0.4%
Current AC	10A	0.1μA	1.2%
Resistance	50MΩ	0.1Ω	0.4%
Capacitance	10mF	0.01nF	1%
Frequency	200kHz	0.01Hz	0.01%
Temperature	1090°C	0.1°C	1%

Battery Life: 88V – Over 400 hours typical (alkaline)

Weight: 88V – 0.36 kg
Lifetime Warranty

Size (HxWxD): 88V – 186 mm x 86 mm x 32 mm

Recommended Accessories



TL82
See page 125



TLK-282-1
See page 125



90i-610s
See page 125



80PK-27 (requires 80AK)
See page 128



PV350
See page 125

8845A/8846A 6.5 Digit Precision Multimeters

FLUKE®



Fluke 8845A



Fluke 8846A

Precision and versatility for bench or systems applications

The Fluke 8845A and 8846A, 6.5 digit precision multimeters have the precision and versatility to handle your most demanding measurements on the bench or in a system.

Dual Display offers versatile graphical capabilities: The 8845A and 8846A features a unique graphical display that can reveal signal quality issues like drift, intermittent and stability by viewing the measurement data as a real time TrendPlot™, Histogram or Statistics using the unique analyze mode.

Wide Measurement Ranges: Resistance or current has been extended to cover the widest range possible.

Perform 4-wire measurements easily with two leads: Patented split terminal jacks for 2x4 Ohms function allows you to perform precise 4-wire measurements with only two leads instead of four.

Optional Kelvin leads accessories are available to enable you to establish a 4-wire connection even in tight spaces.

Systems Capabilities: Both instruments include an RS-232, IEEE-488 and Ethernet interface as standard, with popular DMM emulation modes makes systems integration a simple task.

Software: Transfer data points from your meter to your PC with the free copy of FlukeView Forms Basic. To customize your forms upgrade with FVF-UG.



Use the built-in TrendPlot paperless chart recorder to graphically identify the extent of drift and intermittent events in analog circuits



View results in Histogram mode to reveal stability or noise problems in analog circuits



Handle even the most demanding measurements with high accuracy and 6.5 digit resolution



Included Accessories

LCI Line Power Cord, Test Lead Set, Spare Line Power fuse, Programmers Manual/ User Manual on CD-ROM, 884X-USB USB to RS232 Cable Adapter, FVF-BASIC FlukeView Forms Software Basic Version.

Ordering Information

Fluke 8845A 6.5 Digit Precision Multimeter
 Fluke 8845A/SU 6.5 Digit Precision Multimeter (software + cable)
 Fluke 8846A 6.5 Digit Precision Multimeter
 Fluke 8846A/SU 6.5 Digit Precision Multimeter (software + cable)
 Calibration & Service agreements

Features

	8845A	8846A
Display	Dual VFD Dot Matrix	
Resolution	6.5 Digits	
Measurement Rate (Rdgs/s)	1000	
Continuity / Diode Test	Yes	
Analytical Functions	Statistics, Histogram, TrendPlot™, Limit Compare	
Math Functions	NULL, Min/Max, dB/dBm	
USB Device Port	-	USB Memory Drive port
Real Time Clock	-	Yes
Interfaces	RS232, IEEE-488.2, Ethernet	
Programming Languages/Emulation Modes	SCPI (IEEE-488.2), Agilent 34401A, Fluke 45	
Safety	Designed to comply with IEC 61010-1:2000-1, ANSI / ISA-S82.01-1994, CAN / CSA-C22.2 No.1010-1-92 1000V CATI / 600V CATII	

Specifications

(Check the Fluke web for detailed specifications)

Function*	8845A			8846A		
	Range	Resolution	Accuracy* (%)	Range	Resolution	Accuracy* (%)
Voltage DC	1000 V	100 nV	0.0035	1000 V	100 nV	0.0024
Voltage AC (Freq 300 Hz)	750 V	100 nV	0.06	1000 V	100 nV	0.06
Resistance (2x4 Wire)	100 MΩ	100 μΩ	0.01	1 GΩ	10 μΩ	0.01
Current DC	10 A	100 pA	0.05	10 A	100 pA	0.05
Current AC (Freq. 3Hz-10kHz)	10 A	10 μA	0.10	10 A	100 pA	0.10
Freq/Period	300 kHz	1 μHz	0.01	1 MHz	1 μHz	0.01
Capacitance	-	-	-	1 nF to 100 mF	1 pF	1
Temperature RTD	-	-	-	-200 to +600°	0.001°	0.06

* Accuracy +/- (% of reading)

Size (HxWxD): 88 mm x 215 mm x 293 mm

Weight: 3.6 kg

Three Year Warranty

Recommended Accessories



884X-case
Hard case



TL2X4W-TWZ
2x4 Wire Ohms Tweezer
Test Leads



TL2X4W-PT II
2x4 Wire Ohms Test
lead 2mm Probe Tip



884X-512M
USB Memory 512M



FVF-UG
FlukeView Forms
Software Upgrade

8808A 5.5 Digit Multimeter



Fluke 8808A



The Fluke 8808A includes two low impedance low current ranges for measuring sensitive leakage currents



Use setup keys (S1-S6) for fast access to repetitive measurements. Setups can include limit compare mode with pass/fail indicators



Dual Display



Included Accessories

LCI Line Power Cord, Test Lead Set, Spare Line Power fuse, 884X-USB USB to RS232 Cable Adapter, FlukeView Forms Software Basic Version, Programmers Manual/User Manual on CD-ROM.

Ordering Information

Fluke 8808A 5.5 digit multimeter
 Fluke 8808A/SU 5.5 digit multimeter, (software & cable)
 Fluke 8808A/TL 5.5 digit multimeter, 2X4W Test Lead Kit

Versatile multimeter for manufacturing, development and service applications

Manufacturing test, R&D, development and service applications demand performance and flexibility from a bench meter. The Fluke 8808A delivers a wide variety of measurement functions, including volts, ohms, and amps, plus frequency - all at superior accuracy and resolution with a basic V dc accuracy of 0.015 %.

Measure sensitive leakage current: The Fluke 8808A includes two low impedance low current ranges for measuring sensitive leakage currents (i-Leakage).

Perform routine manufacturing functional tests with consistency: Use setup keys (S1 - S6) for fast access to repetitive measurements. Operators no longer need to press multiple buttons to make routine measurements.

Eliminate production mistakes: The 8808A has a limit compare mode with built in display enunciators that clearly show whether a test is within or out of limits.

Perform 4-wire measurements with only two leads: Patented split terminal jacks for 2x4 Ohms function allow you to perform precise 4-wire low ohms measurements with only two leads instead of four. Optional test lead accessories are available to enable you to establish a 4-wire connection even in tight spaces or on surface mount devices.

Features

	8808A
Display	VFD multi segment
Resolution	5.5 digits
Measurements	V ac, V dc, I dc, I ac, Ω, Cont, Diode
Advanced Measurements	2X4 Wire Ohms, Freq, i-Leakage
Continuity / Diode Test	Yes
Analytical Functions	Limit Compare
Math Functions	dBm, dB, Min, Max
Interfaces	RS-232, USB via optional adapter
Programming Languages/Modes	Simplified ASCII, Fluke 45
Safety Rating	CAT I 1000 V, CAT II 600 V

Specifications

(Check the Fluke web for detailed specifications)

Functions	Range	Resolution	Accuracy*
Voltage DC	200 mV to 1000 V	1 μV	0.015
Voltage AC (Freq. 10 Hz to 100 kHz)	200 mV to 750 V	1 μV	0.2
Resistance (2x4 Wire)	200 Ω to 100 MΩ	1 mΩ	0.02
Current DC	200 μA to 10 A	1 nA	0.02
Current AC (Freq. 20 Hz to 2 kHz)	20 mA to 10A	0.1 μA	0.3
Freq. Period	20 Hz to 1 MHz (Freq. only)	0.1 mHz	0.01

* Accuracy = +/- (% of reading)

Size (HxWxD): 88 mm x 217 mm x 297 mm

Weight: 2.1 kg

Three year Warranty

Recommended Accessories



Clamp Meters and Electrical Testers

The ergonomic clamp meters feature wide opening jaws for safe, fast non-contact current measurement. The Fluke leakage clamp meter is ideal for non-invasive checks of insulation resistance.

The range of electrical testers includes two-pole testers for taking quick measurements in tight spaces, phase rotation indicators to take the guess work out of checking phase/motor rotation, a multipurpose cable locator and handy voltage alerts.

The new Fluke iFlex flexible current probes expand the measurement range of select Fluke meters to 2500 A ac and allow technicians to reach crowded spaces.



Clamps Selection Guide

	Residential/commercial electrical		General purpose				Industrial electrical		HVAC/R	High end industrial, utility		iFlex accessory	Leakage
	321	322	365	373	374	375	376	381	902	353	355	i2500-10/ i2500-18	360*
Measurements													
AC current	●	●	●	●	●	●	●	●	●	●	●	●	●
AC volts	●	●	●	●	●	●	●	●	●	●	●	●	●
Resistance	●	●	●	●	●	●	●	●	●	●	●	●	●
Continuity	●	●	●	●	●	●	●	●	●	●	●	●	●
DC Volts	●	●	●	●	●	●	●	●	●	●	●	●	●
DC current	●	●	●	●	●	●	●	●	●	●	●	●	●
True-rms	●	●	●	●	●	●	●	●	●	●	●	●	●
Frequency	●	●	●	●	●	●	●	●	●	●	●	●	●
AC + DC voltage	●	●	●	●	●	●	●	●	●	●	●	●	●
AC + DC current	●	●	●	●	●	●	●	●	●	●	●	●	●
Min/Max/Avg	●	●	●	●	●	●	●	●	●	●	●	●	●
Temperature	●	●	●	●	●	●	●	●	●	●	●	●	●
Capacitance	●	●	●	●	●	●	●	●	●	●	●	●	●
Special features													
Inrush current mode	●	●	●	●	●	●	●	●	●	●	●	●	●
Low Pass filter	●	●	●	●	●	●	●	●	●	●	●	●	●
Harmonics, power, data logging	●	●	●	●	●	●	●	●	●	●	●	●	●
18-inch iFlex Flexible Current Probe	●	●	●	●	●	●	●	●	●	●	●	●	●
10-inch iFlex Flexible Current Probe	●	●	●	●	●	●	●	●	●	●	●	●	●
Remote display	●	●	●	●	●	●	●	●	●	●	●	●	●
Flashlight/torch	●	●	●	●	●	●	●	●	●	●	●	●	●
Display													
Display hold	●	●	●	●	●	●	●	●	●	●	●	●	●
Backlight	●	●	●	●	●	●	●	●	●	●	●	●	●
Graphing display	●	●	●	●	●	●	●	●	●	●	●	●	●
Specifications													
Jaw opening	25.4 mm	25.4 mm	18 mm	32 mm	34 mm	34 mm	34 mm	34 mm	30.5 mm	58 mm	58 mm	7.5 mm coil	40 mm
Current range ac rms	0 to 400.0 A	0 to 400.0 A	0 to 200.0 A	0 to 600.0 A	0 to 600.0 A	0 to 600.0 A	0 to 999.9 A	0 to 999.9 A	0 to 600.0 A	0 to 1400 A	0 to 1400 A	0 to 2500 A	0 to 60 A
Accuracy ac current (50/60 Hz)	± 5 counts	± 5 counts	± 5 counts	± 5 counts	± 5 counts	± 5 counts	± 5 counts	± 5 counts	± 5 counts	± 5 counts	± 5 counts	± 5 counts	± 5 counts
AC Response	Averaging	Averaging	True-rms	True-rms	True-rms	True-rms	True-rms	True-rms	True-rms	True-rms	True-rms	True-rms	Averaging
Current range dc	0 to 200 A	0 to 200 A	0 to 200 A	0 to 600.0 A	0 to 600.0 A	0 to 600.0 A	0 to 999.9 A	0 to 999.9 A	0 to 200 µA	0 to 2000 A	0 to 2000 A	0 to 2000 A	0 to 2000 A
Accuracy dc current	± 5 counts	± 5 counts	± 5 counts	± 5 counts	± 5 counts	± 5 counts	± 5 counts	± 5 counts	± 5 counts	± 5 counts	± 5 counts	± 5 counts	± 5 counts
Voltage range ac	0 to 600.0 V	0 to 600.0 V	0 to 600.0 V	0 to 600.0 V	0 to 600.0 V	0 to 600.0 V	0 to 1000 V	0 to 1000 V	600.0 V	0 to 600.0 V	0 to 600.0 V	0 to 600.0 V	0 to 600.0 V
Accuracy ac voltage	± 5 counts	± 5 counts	± 5 counts	± 5 counts	± 5 counts	± 5 counts	± 5 counts	± 5 counts	± 5 counts	± 5 counts	± 5 counts	± 5 counts	± 5 counts
Voltage range dc	0 to 600.0 V	0 to 600.0 V	0 to 600.0 V	0 to 600.0 V	0 to 600.0 V	0 to 600.0 V	0 to 1000 V	0 to 1000 V	0 to 600.0 V	0 to 1000 V	0 to 1000 V	0 to 1000 V	0 to 1000 V
Accuracy dc voltage	± 5 counts	± 5 counts	± 5 counts	± 5 counts	± 5 counts	± 5 counts	± 5 counts	± 5 counts	± 5 counts	± 5 counts	± 5 counts	± 5 counts	± 5 counts
Resistance range	0 to 400 Ω	0 to 400 Ω	0 to 6000 Ω	0 to 6000 Ω	0 to 6000 Ω	0 to 6000 Ω	0 to 60 kΩ	0 to 60 kΩ	0 to 9999 Ω	0 to 400 kΩ	0 to 400 kΩ	0 to 400 kΩ	0 to 400 kΩ
Frequency measurement range			500 Hz	500 Hz	500 Hz	500 Hz	500 Hz	500 Hz	5 to 1000 Hz	5 to 1000 Hz	5 to 1000 Hz	500 Hz	500 Hz
Unit power													
Auto off	●	●	●	●	●	●	●	●	●	●	●	●	●
Warranty and safety													
Warranty (years)	2	2	3	3	3	3	3	3	3	3	3	3	1
Category ratings (EN61010-1)	CAT III 600 V	CAT III 600 V	CAT III 600 V	CAT III 600 V, CAT IV 300 V	CAT III 1000 V, CAT IV 600 V	CAT III 1000 V, CAT IV 600 V	CAT III 1000 V, CAT IV 600 V	CAT III 1000 V, CAT IV 600 V	CAT III 600 V	CAT III 1000 V, CAT IV 600 V	CAT III 1000 V, CAT IV 600 V	CAT III 1000 V, CAT IV 600 V	CAT III 300 V

381 Remote Display True-rms AC/DC Clamp Meter with iFlex™

New



True RMS



All the bells and whistles

The Fluke 381 Clamp Meter combines iFlex flexibility with remote reading capability for the ultimate in innovation and safety.

- Remote display reads measurements up to 30 feet away
- iFlex flexible current probe included, 18-inch circumference
- 2500 A ac current measurement with iFlex
- 1000 A ac and dc current measurement with fixed jaw
- 1000 V ac and dc voltage measurement
- Frequency measurement to 500 Hz
- 60 k Ω resistance measurement
- Min/Max/Avg and inrush recording
- CAT IV 600 V, CAT III 1000 V
- Three-year warranty

See specifications chart on page 24.

365 Detachable Jaw True-rms AC/DC Clamp Meter

New



True RMS



Where rugged meets reliable

The Fluke 365 Clamp Meter offers a small, detachable jaw—with four feet of coil—that makes it easy to take and read measurements in tight or hard-to-reach places.

- 200 A ac and dc current measurement
- 600 V ac and dc voltage measurement
- 6000 Ω resistance measurement
- Built-in flashlight
- Large, easy-to-read backlight display
- Three-year warranty

See specifications chart on page 24.

Included Accessories

18-inch iFlex™ Flexible Current Probe (Fluke 381), test leads, soft carrying case, instruction card, safety information sheet, two AA alkaline batteries.

Ordering Information

Fluke 381 Remote Display True-rms AC/DC Clamp Meter with iFlex™
 Fluke 365 Detachable Jaw True-rms AC/DC Clamp Meter

Recommended Accessories



TL223-1
See page 122

TL175
See page 124

370 Series Clamp Meters

New



Fluke 376 (with i2500)



Fluke 375 Fluke 374 Fluke 373



Fluke i2500



Be ready for anything

Our new family of true-rms clamp meters provides a range of state-of-the-art features to meet even the most demanding job requirements. All four of the new clamp meters have improved base features such as a large, backlit display, true-rms standard, CAT IV

safety rating and a durably constructed body. Additionally, the 376, 375 and 374 are compatible with the iFlex flexible current probe (included with the 376, sold separately for the 375 and 374), and provide increased measurement readings to 1000 A and 1000 V ac and dc.

Features

	373	374	375	376
True-rms	●	●	●	●
AC current	●	●	●	●
AC voltage	●	●	●	●
Resistance	●	●	●	●
Continuity	●	●	●	●
DC volts	●	●	●	●
DC current		●	●	●
Frequency			●	●
Low pass filter			●	●
Inrush current mode		●	●	●
18-inch iFlex Flexible Current Probe		Optional	Optional	Included
10-inch iFlex Flexible Current Probe		Optional	Optional	Optional

Specifications

Functions	Range	373	374	375	376
Current AC	0 to 600.0 A	2% ± 5 counts	2% ± 5 counts	2% ± 5 counts	
	0 to 999.9 A				2% ± 5 counts
Current DC	0 to 600.0 A		2% ± 5 counts	2% ± 5 counts	
	0 to 999.9 A				2% ± 5 counts
Voltage AC	0 to 600.0 V	1% ± 5 counts	1.5% ± 5 counts	1.5% ± 5 counts	1.5% ± 5 counts
Voltage DC	0 to 600.0 V	1% ± 5 counts	1% ± 5 counts	1% ± 5 counts	
	0 to 1000 V				1% ± 5 counts
Resistance range		0 to 6000 Ω	0 to 6000 Ω	0 to 6000 Ω	0 to 60 kΩ
Jaw opening		32 mm	34 mm	34 mm	34 mm
Max. wire size		750 MCM	750 MCM	750 MCM	750 MCM
Frequency measurement range				500 Hz	500 Hz

iFlex™ Flexible Current Probe

The new Fluke iFlex flexible current probes expand the measurement range of select Fluke meters to 2500 A ac and allow technicians to reach crowded spaces.

- Expands the measurement range to 2500 A ac while providing increased display flexibility, ability to measure awkward sized conductors and improved wire access
- Compatible to Fluke 374, 375, 376 and 381
- CAT IV 600 V, CAT III 1000 V
- 7.5 mm coil diameter allows measurement in tight spaces
- Ergonomic design allows easy operation with one hand
- 1.8 m (6 ft) cable
- Three-year warranty

Included Accessories

18-inch iFlex™ flexible current Probe (Fluke 376), test leads, soft carrying case, instruction card, safety information sheet, two AA alkaline batteries.

Ordering Information

- Fluke 376 True-rms AC/DC Clamp Meter with iFlex™
- Fluke 375 True-rms AC/DC Clamp Meter
- Fluke 374 True-rms AC/DC Clamp Meter
- Fluke 373 True-rms AC Clamp Meter
- i2500-10 iFlex™ Flexible Current Probe 25 cm (10 in)
- i2500-18 iFlex™ Flexible Current Probe 45 cm (18 in)

Recommended Accessories



TL223-1
See page 122

AC285
See page 124

TL175
See page 124

320 Series Clamp Meters



Fluke 322

Fluke 321



Get more done

The Fluke 321 and 322 are designed to verify the presence of load current, ac voltage and continuity of circuits, switches, fuses and contacts. These small and rugged clamp meters are ideally suited for current measurements up to 400 A in tight cable environments.

- Precised measurements with 1.8 % basic accuracy

- Resolution up to 0.01 A and 0.1 V
- Measures ac current 40.00 A/400.0 A
- Measures ac and dc volts to 600 V
- Resistance measurement to 400 Ω
- Continuity for quick checking of shorts

See specifications chart on page 24 for details per model.

Features

	321	322	902
True-rms			•
AC current	•	•	•
AC voltage	•	•	•
Resistance	•	•	•
Continuity	•	•	•
DC volts		•	•
DC current			•
Min/Max/Avg			•
Temperature			•
Capacitance			•

902 True-rms HVAC Clamp Meter



Fluke 902



True RMS



Just for our HVAC pros

HVAC (heating, ventilation, air conditioning) technicians require a service tool that can consistently keep up with their demands. The Fluke 902 expands the existing line of quality Fluke clamp meters by delivering the features necessary to diagnose and repair HVAC systems. Combined with true-rms technology and a CAT III 600 V rating, the Fluke 902 helps technicians do their jobs safely and accurately.

- Designed for HVAC applications with capacitance, dc current (µA), and temperature measurements

- Small body and jaws fit perfectly in your hand and into tight places
- Handy “Display Hold” button keeps measurements on the display
- Meter controls are positioned so current measurements can be done with one hand (index finger on clamp opening lever and thumb on rotary switch)
- Three-year warranty

See specifications chart on page 24.

Specifications

Functions	Range	321	322	902
Current AC	0 to 400.0 A	1.8% ± 5 counts	1.8% ± 5 counts	
	0 to 600.0 A			2% ± 5 counts
Current DC	0 to 200.0 A			1% ± 5 counts
Voltage AC	0 to 600.0 V	1.2% ± 5 counts	1.2% ± 5 counts	
	600.0 V			1% ± 5 counts
Voltage DC	0 to 600.0 V		1% ± 5 counts	1% ± 5 counts
Resistance range		0 to 400 Ω	0 to 400 Ω	0 to 9999 Ω
Jaw opening		25.4 mm	25.4 mm	30.5 mm
Max. wire size		500 MCM	500 MCM	750 MCM

Included Accessories

Test leads, temperature probe (Fluke 902), soft carrying case, instruction card, safety information sheet, two AA alkaline batteries.

Ordering Information

Fluke 321 Clamp Meter
 Fluke 322 Clamp Meter
 Fluke 902 True-rms HVAC Clamp Meter

Recommended Accessories



TL223-1
See page 122

TL175
See page 124

LVD2
See page 32

H3
See page 131

350 Series AC/DC Clamp Meters



Fluke 353



Fluke 355



True-RMS, 2000 A Clamp Meters for industrial and utility applications

Confidently take reliable readings with the true-rms, Fluke 353/355 Clamp Meters; the tools of choice for high current measurement up to 2000 A. The extra-wide jaw easily clamps around large conductors, typically found in high current applications. The rugged design and CAT IV 600 V, CAT III 1000 V ratings add an extra element of protection when taking high-powered measurements.

Accurate peak measurements can be taken using the in-rush current mode - ideal for motors and inductive loads. The 355 also measures voltage and resistance, making this the most versatile tool for utilities, electrical contractors and industrial service technicians.

Features

	353	355
True-RMS measurements	●	●
Display backlight	●	●
Motor start-up current	●	●
Min/Max/Average	●	●
Voltage AC/DC		●
Resistance measurement		●
Continuity measurement with beeper		●

Specifications

(Check the Fluke web for detailed specifications)

Functions	Range	353	355
Current AC/DC	0-40.00 A	1.5% ± 15 counts	1.5% ± 15 counts
	0-400.0 A		
	0-2000 A; 1400 AC rms	1.5% ± 5 counts	1.5% ± 5 counts
Crest Factor		2.4	2.4
Voltage AC/DC	0-4.000 V		1% ± 10 counts
	0-40.00 V		
	0-400.0 V		
	0-600 V AC rms		1% ± 5 counts
	0-1000 V DC		
Resistance	0-400.0 Ω		
	0-4.000 kΩ		
	0-40.00 kΩ		1.5% ± 5 counts
	0-400.0 kΩ		
Continuity beeper	Appr. ≤ 30 Ω		
Frequency	5.0Hz to 100.0Hz		0.2% ± 2 counts
	100.1Hz to 999Hz		0.5% ± 5 counts

Included Accessories

Fluke 353: C43 Soft Meter Case, 6 AA batteries, users manual
 Fluke 355: C43 Soft Meter Case, 6 AA batteries, TL224 SureGrip® Silicone Test Lead Set, TP2 Slim Reach Test Probe Set (2 mm), AC285 SureGrip® Alligator Clip Set, users manual

Ordering information

Fluke 353 AC/DC Clamp Meter
 Fluke 355 AC/DC Clamp Meter

Power Supply:

6 x 1.5V AA NEDA 15A or IEC LR6

Battery Life:

100 hours (with typical usage, backlight off)

Size (HxWxD): 300 mm x 98 mm x 52 mm

Jaw opening: 58 mm

Weight: 0.814 kg

Two year warranty

Recommended Accessories



TL223-1 (Fluke 355)
See page 122



L215 (Fluke 355)
See page 123

360 Leakage Clamp Meter



Fluke 360

Leakage current measurements with a tough, pocket sized clamp meter

The Fluke 360 is ideal for non-invasive checks of insulation resistance. The unique jaw design eliminates the influence of adjacent current conductors. The ergonomic design of the Fluke 360 ensures easy measuring. The measuring clamp fits into tight spaces and the wide display angle clearly shows the measurement result. The data hold button keeps the measured value on the display after removing the clamp for the measured conductor.

The light Fluke 360 offers the widest range of current measurement for maintenance professionals and contractors.

Features

- Measurement of leakage protectives conductor and touch current with a resolution of 1µA
- Advanced shielding to ensure accurate results when measuring near other conductors
- Automatic ranging within the manually selected mA or A range
- Easily viewed measurements on digital and bargraph display and HOLD when measuring in hard to see locations
- Broad range of measurements currents up to 60 A for all installation needs
- Easy carrying, pocket sized clamp with wide 40 mm jaw size
- Display-Hold for convenience in use
- Auto power off with audible warning buzzer
- Conformance to IEC61010 and EMC standard
- Meets all the applications and performance classes in safety standard VDE0404-4 and the new VDE0702



Included accessories

Soft carrying pouch and users manual

Ordering information

Fluke 360 Leakage Clamp Meter

Specifications

(Check the Fluke web for detailed specifications)

Functions	Range	Resolution	Accuracy
Current AC	3mA	0.001A	1% ± 5 counts
	30mA	0.01mA	
Frequency	30A	0.01A	1% ± 5 counts (0-50A)
	60A	0.1A	5% ± 5 counts (50-60A)

Battery type: 3 Volt Lithium, 90 hours typical

Size (HxWxD): 176 mm x 70mm x 25 mm

Weight: 0.2kg

One Year warranty

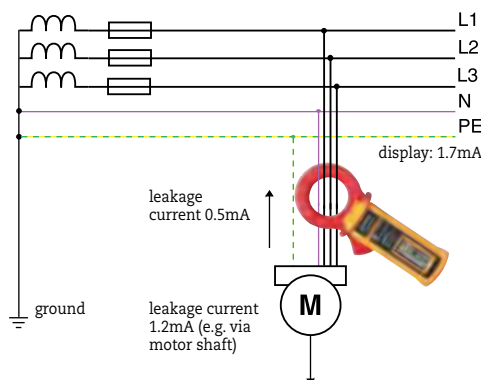

T100 Series Voltage and Continuity Testers

FLUKE®



Fluke T120

Fluke T140

Fluke T100

The fast and easy solution to voltage, continuity and phase rotation testing

The fast and easy solution to voltage, continuity and resistance measurements. Ideal for site conditions, the 3 models of the T100 Series 2-pole testers have a rugged construction and ergonomically formed housing for perfect handling. All models offer a patented three-phase rotation detection system providing quick phase rotation indication.

Moreover they have a special electrical torch function for working in low light level environments and have an ingress protection rating of IP65. The T100 Series are compliant with EN 61010-1 and EN61243-3 requirements.

Features

	T100	T120	T140
Display		LCD	LCD
Led Bargraph	12 LED's	12 LED's	12 LED's
Backlight			●
Resistance measurement			●
Switchable load			●
Voltage test	●	●	●
Optical and acoustical continuity test	●	●	●
Rotary field indication	●	●	●
Single pole test for phase detection	●	●	●
Indication of polarity	●	●	●
Electrical torch function	●	●	●
Probe tip protection	●	●	●
The voltage display also functions when using discharged - or o batteries	●	●	●

Specifications

	T100	T120	T140
Voltage AC/DC	12 - 690 V	12 - 690 V	12 - 690 V
Continuity	0 - 400 kΩ	0 - 400 kΩ	0 - 400 kΩ
Frequency	0 - 400 Hz	0 - 400 Hz	0 - 400 Hz
Phase rotation	100 to 690 V	100 to 690 V	100 to 690 V
Resistance measurement	-	-	Up to 1999 Ω
Response time	< 0.1 s	< 0.1 s	< 0.1 s

Included Accessories

Two 1.5V batteries and instruction sheet

Ordering Information

Fluke T100 Voltage/Continuity Tester
 Fluke T120 Voltage/Continuity Tester
 Fluke T140 Voltage/Continuity Tester

UK versions are compliant with GS38

Size (HxWxD): 240 mm x 56 mm x 24 mm
Case: IP65 (water-jet and dust tight protection)
Weight: 180 g
Two year warranty

Recommended Accessories



C33 (T100 Series)
See page 130

T5 Electrical Testers



Fluke T5-1000
(incl. TP1-1 test probes)

Fluke T5-600
(incl. TP1-1 test probes)



Fluke T5-H5-1AC Kit

Fluke T5-600/62/1AC-E Kit

The fast and easy solution to basic electrical testing

The Fluke T5 testers let you check voltage, continuity and current with one compact tool. Select volts, ohms or current and the instrument does the rest. Model T5-600 measures 600 volts AC/DC, model T5-1000 is designed for 1000 volts. OpenJaw™ current technology lets you check current up to 100 A, without breaking the circuit. The optional H5 holster keeps the test probes and leads ready to test and lets you clip the T5 onto your belt.

Features and Specifications

	T5-600	T5-1000
Display Count	1000	1000
Automatic Selection	●	●
Continuity and Bleeper	●	●
Sleep Mode	●	●
AC Voltage	600 V	1000 V
DC Voltage	600 V	1000 V
AC Current	100 A	100 A
Resistance	1000 Ω	1000 Ω
Safety range	600V CAT III	1000 V CAT III / 600 V CAT IV

Battery life: 400 hours
Size (HxWxD):
203 mm x 51 mm x 30.5 mm

Weight: 0.38 kg
Two year warranty

Fluke T5-H5-1AC Kit

The ideal kit for busy electrical contractors and electricians. The benefits of a voltage and current meter and non-contact voltage detector all in one kit. A holster for the T5 is also included.

- Kit includes:
- Fluke T5-1000
 - H5 holster
 - Free Fluke 1AC-II

Fluke T5-600/62/1AC-E Kit

This kit is designed to help electricians and HVAC technicians solve problems quicker. Test first for overheated electrical devices using an IR thermometer; then use electrical test tools to find out more about the problem.

- Kit includes:
- Fluke T5-600
 - Fluke 62
 - Fluke 1AC II
 - C115

Included Accessories

2 TP38 detachable probe (CAT III),
2 TP1-1 detachable probe (CAT II),
(detachable GS38 probes for the UK)
and instruction sheet

Ordering Information

Fluke T5-600	Electrical Tester
Fluke T5-1000	Electrical Tester
Fluke T5-H5-1AC Kit	Electrical Tester with holster and IAC
Fluke T5-600/62/1AC-E	Electrical Tester, IR Thermometer, Voltage Detector Kit

Recommended Accessories



H5
See page 131



ACC-T5-Kit
See page 123



AC285
See page 124

1AC II/2AC Volt Alerts LVD1/LVD2 Volt Lights



Fluke 1AC II



Fluke 1AC II VoltAlert™

The Fluke VoltAlert AC voltage detector is very easy to use – just touch the tip to a terminal strip, outlet or cord. When the tip glows red and the unit beeps, you know there is voltage on the line.

- It continually tests its battery and its circuit integrity with a periodic double flash visual indication.
- Highest safety rating: CAT IV 1000 V
- Detects voltage without metallic contact



Operating range: 200 – 1000 V AC
Batteries: Two AAA Alkaline
Size (H): 148 mm
Two Year Warranty

Fluke 1AC II VoltAlert™ 5-pack

- Buy 4 get 1 FREE



Fluke 2AC VoltAlert™



2AC VoltAlert™

2AC is the latest addition to the VoltAlert™ ac non-contact voltage tester family from Fluke and is designed to be pocket-sized and easy to use. The 2AC tests for energized circuits and defective grounds, whether it's for an electrician on the factory floor or the do-it-yourselfer around the house. The tip of the pocket-sized tester will glow red when within close proximity of an outlet, terminal strip, or power cord where voltage is present.

- Voltage detection from 200 to 1000 V ac, suitable for a wide range of residential, commercial and industrial needs.
- NEW! Always on, using special low power circuitry to sustain battery life and ensure your 2AC is always ready.
- NEW! Innovative 'Battery Check' button function ensures battery is in good condition*
- Category IV – 1000 V overvoltage rated product for best in class user protection
- Integrated clip design, optimized for pocket storage
- Powered by 2x AAA batteries (included)
- Fluke ruggedness and reliability
- Two-year warranty storage.
- Powered by 2x AAA batteries (included)- Fluke reliability and ruggedness, Two-year warranty.



Operating range: 200 – 1000 V AC
Batteries: Two AAA Alkaline
Size (H): 148 mm
Two Year Warranty

Fluke 2AC VoltAlert™ 5-pack

- Buy 4 get 1 FREE



LVD2



LVD2 Volt Light

Combines bright light and voltage detection in one pen style design

- Dual sensitivity
- Detects voltage from 90 V to 600 V AC
- Blue light means you're close
- Red light means you're at the source
- Rated to CAT IV 600 V



LVD1











LVD1 Volt Light

Dual sensitivity voltage detector

- Detects voltage from 40 V to 300 V AC
- Blue light means you're close
- Red light means you're at the source
- Comes with a versatile clip to secure light to pocket, hat or even panel door

Ordering Information

Fluke 1AC II	Volt Alert
Fluke 1AC II	Volt Alert (5-pack)
Fluke 2AC	Volt Alert
Fluke 2AC	Volt Alert (5-pack)
LVD2	Volt Light
LVD1	Volt Light

			
Features	2AC 200-1000 V AC CAT IV 1000 V	1AC-II 200-1000 V AC CAT IV 1000 V	LVD2 90-600 V AC CAT IV 600 V
 Voltage Detection	■	■	■
 Battery Included	■	■	■
 Battery Check	■		
 On/Off Button		■	■
 Voltbeat™		■	
 Audible/Silent		■	
 Dual Sensitivity			■
 LED Flashlight			■

9040/9062 Phase Rotation Indicators

FLUKE®



Fluke 9040

Fluke 9062

Take the guess work out of phase/motor rotation measurements

Fluke 9040

The Fluke 9040 is effective for measuring phase rotation in all areas where three-phase supplies are used to feed motors, drives and electrical systems. The Fluke 9040 is a rotary field indicator and can provide clear indication of the 3 phase via an LCD display and the phase rotation direction to determine correct connections. It allows rapid determination of phase sequence and has a voltage (up to 700 V) and frequency range suitable for commercial and industrial applications. Test probes supplied with the instrument have a variable clamping range for safe contact, especially in industrial sockets.

Fluke 9062

The unique Fluke 9062 provides rotary field and motor rotation indication with the benefits of contact-less detection. Purpose made for commercial and industrial environments, the Fluke 9062 provides rapid indication of 3 phase rotation using test leads supplied or can be used to determine motor rotation on synchronous and asynchronous 3 phase motors. The contact-less detection is ideal for use on motors where the shaft is not visible. Test probes supplied with the instrument have a variable clamping range for safe contact, especially in industrial sockets.

Features

	9040	9062
3 phase indication	Via LCD	Via LED
Indication of phase rotation	●	●
Indication of motor rotation direction		●
Contact free determination of the rotation direction of running motors		●
Clear LCD display	●	
No battery required	●	

9040:



9062:



Specifications

	9040	9062
Voltage range	40 - 700 V	Up to 400 V
Phase display	-	120 - 400 V AC
Frequency range	15 - 400 Hz	2-400 Hz
Operating time	Continuous	Continuous

Size (HxWxD) Fluke 9040:

124 mm x 61 mm x 27 mm

Size (HxWxD) Fluke 9062:

124 mm x 61 mm x 27 mm

Power supply 9040:

from unit under test

Power supply 9062:

1 x 9V

Weight 9040: 0.20 kg

Weight 9062: 0.15 kg

Two Year Warranty

Included Accessories

Fluke 9040: Alligator clips - black (3)

Standard test probes - black (3)

Flexible test probes - black (3)

Fluke 9062: Alligator clips - black (3)

Flexible test probes - black (3)

Test leads - black (3)

Ordering Information

Fluke 9040 Phase Rotation Indicator

Fluke 9062 Motor and Phase Rotation Indicator

Fluke 9062 Applications



Determine the presence of phase sequence of multiphase electrical supplies.



Determine the rotation of running motors simply by placing the instrument on the motor casing.



Check the correct rotation of motors prior to connection.

Recommended Accessories



TLK290
See page 123



TLK291
See page 123



C25
See page 130

2042 Cable Locator



Receiver

Transmitter

Fluke 2042



Included Accessories

- TL27 Heavy Duty Test Lead Set (2)
- TP74 Lantern Tip Test Probe Set
- AC285 Alligator Clip Set
- Soft carrying case
- Hard case

Ordering Information

- Fluke 2042 Cable Locator (transmitter + receiver)
- Fluke 2042T Cable Locator Transmitter

The multipurpose solution to cable location

The Fluke 2042 is a professional general purpose cable locator. It is ideal for tracing cables in walls and underground, locating fuses/breakers on final circuits and locating interruptions and short-circuits in cables and electrical floor heating systems. It can also be used for tracing metallic water and heating pipes. The unit is supplied as a complete kit comprising of a transmitter and receiver in a purpose-made carry case. The receiver also incorporates a torch function for working in dimly lit locations.

- For all applications (live or dead cables) without additional instruments
- Set includes a transmitter and a receiver
- Proven digitally coded sender signal guarantees clear signal identification
- Transmitter with LCD-display for transmitting level, transmitting code and external voltage

- Receiver with a backlight LCD-display for level of receiving signal, code of receiving signal and live voltage indication
- Automatic or manual adjustment of receiving signal sensitivity
- Switchable acoustic receiving signal
- Auto-Power-Off
- Additional torch lamp function for working in dark environments
- Additional transmitters are available for extension or to distinguish between several signals.

Specifications

	Transmitter	Receiver
Voltage Measurement Range	12V, 50V, 120V, 230V, 400V	
Frequency Range	0..60 Hz	
Output signal	125 kHz	
Voltage	Up to 400V AC/DC	
Tracing depth cable location		0...2.5m wall/underground cables
Main voltage detection		0...0.4m

Batteries Transmitter: 6 pc Batteries 1.5V

Batteries Receiver: 1 pc Battery 9V

Size (HxWxD) Transmitter:

190 mm x 85 mm x 50 mm

Size (HxWxD) Receiver:

250 mm x 65 mm x 45mm

Weight Locator: 0.45 kg

Weight Receiver: 0.36 kg

Two Year Warranty

Fluke 2042 applications



Location of fuses/breakers and assignment to circuits



Tracing of underground cables (max. depth 2.5 m)

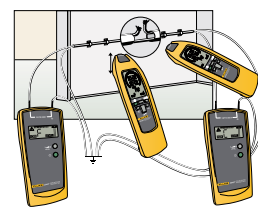

Precise location of cable interruptions with additional transmitter

Recommended Accessories



Fluke 2042T

Insulation Testers and Earth Ground Testers

With a 10kV insulation resistance tester and a range of compact hand-held instruments, we offer a solution for every troubleshooting and preventive application.

Two of the digital hand-held insulation testers also include full-featured multimeters.

The Fluke Earth Ground Testers can perform all four types of earth ground measurement, including stakeless testing with earth ground loop resistances using only clamps.

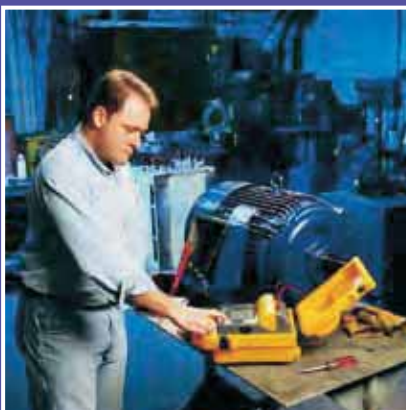

Insulation Tester Selection Guide

FLUKE®



	1577	1587	1587T	1503	1507	1550C	1555
Installation Test Functionality							
Test voltages	500V, 1000V	50V, 100V, 250V, 500V, 1000V	50V, 100V	500V, 1000V	50V, 100V, 250V, 500V, 1000V	250V, 500V, 1000V, 2500V, 5000V	250V, 500V, 1000V, 2500V, 5000V, 10000V
Insulation Resistance Test Range	0.1MΩ - 600MΩ	0.01 MΩ - 2GΩ	0.01MΩ - 100MΩ	0.1MΩ - 2GΩ	0.01MΩ - 10GΩ	200KΩ - 1TΩ	200KΩ - 2TΩ
Polarization Index/Dielectric Absorption Ratio					●	●	●
Auto Discharge	●	●	●	●	●	●	●
Time Ramp test (Breakdown)						●	●
Pass/Fail Comparison					●		
Estimated Number of Insulation resistance Tests	1000	1000	1000	1000	1000	1000 @ 5000 V	1000 @ 10000 V
Voltage > 30V Warning	●	●	●	●	●	●	●
Memory						(99 locations)	(99 locations)
Remote Test Probe	●	●	●	●	●		
Lo Ohms				●	●		
Display	Digital LCD	Digital LCD	Digital LCD	Digital LCD	Digital LCD	Digital LCD / Analog Bar Graph	Digital LCD / Analog Bar Graph
Continuity	●	●	●	(200mA)	(200mA)		
Multimeter Functionality							
AC/DC Volts	●	●	●	●	●		
Current	●	●	●				
Resistance	●	●	●	●	●		
Temperature (contact)		●	●				
Lo-Pass Filter		●	●				
Capacitance		●	●			●	●
Diode Test		●	●				
Frequency		●	●				
MIN/MAX		●	●				
Other							
Hold/Lock	●	●	●	●	●	●	●
Backlight	●	●	●	●	●		
Software						(Fluke View® Forms Basic)	(Fluke View® Forms Basic)
Warranty (in years)	3	3	3	1	1	3	3
Battery	4 AA (NEDA 15A or IEC LR6)	4 AA (NEDA 15A or IEC LR6)	4 AA (NEDA 15A or IEC LR6)	4 AA (NEDA 15A or IEC LR6)	4 AA (NEDA 15A or IEC LR6)	Rechargeable	Rechargeable



Fluke 1587/ET

Buy a Fluke 1587 Combo Kit and save

Fluke 1587/ET Advanced Electrical Troubleshooting Kit

- This kit contains:
- Fluke 1587 Insulation Multimeter
 - Fluke 62 Mini Infrared Thermometer
 - i400 Current Clamp

Perform insulation tests with the Fluke 1587 plus a wide-range of DMM tasks with confidence and ease. Use the i400 with your Fluke 1587 to accurately measure AC current without breaking the circuit. Check for hot spots and measure temperature with the Fluke 62 Mini non-contact thermometer.

Fluke 1587/MDT Advanced Motor & Drive Troubleshooting Kit

- This kit contains:
- Fluke 1587 Insulation Multimeter
 - Fluke 9040 Phase Rotation Indicator
 - i400 Current Clamp

Perform insulation tests with the Fluke 1587 plus a wide-range of DMM tasks with confidence and ease. Use the i400 with your Fluke 1587 to accurately measure AC current without breaking the circuit. Check the phase-rotation of three-phase motors easily and safely with the Fluke 9040.



Fluke 1587/MDT

1577/1587 Insulation Multimeters

FLUKE®



Fluke 1577

Fluke 1587
Fluke 1587T



Included Accessories

C101 Rugged, utility hard case
TL224 SureGrip Silicone Test Lead Set
AC285 SureGrip Alligator Clip Set
80BK Integrated DMM Temperature Probe (Type K)
TP165X Remote Test Probe

Ordering Information

Fluke 1577 Insulation Multimeter
Fluke 1587 Insulation Multimeter
Fluke 1587T Insulation Multimeter (for Telecom)

Two powerful tools in one

The Fluke 1587 and 1577 Insulation Multimeters combine a digital insulation tester with a full-featured True RMS digital multimeter in a single compact, handheld unit, which provides maximum versatility for both troubleshooting and preventive maintenance.

Whether you work on motors, generators, cables, or switch-gear, the Fluke 1587/1577 Insulation Multimeters are ideally suited to help you with your tasks.

The Fluke 1587T is specially designed for the telecom environment.

Features

Multimeter Features	1577	1587	1587T
True RMS Voltage and Current for accurate measurements	●	●	●
Digital display counts	6000	6000	6000
Autorange and manual range for easy testing.	●	●	●
Selectable filter for accurate voltage and frequency measurements on motor drives		●	●
Min Max Recording, Diode test, temperature, capacitance & frequency measurement for maximum flexibility.		●	●
Insulation features			
User selectable test voltages for many applications	●	●	
Additional test voltages 50V, 100V, 250V		●	
Special remote control probe for easy and safe measurements	●	●	●
Auto-discharge of capacitive voltage for added user protection	●	●	●
Live circuit detection prevents insulation test if voltage > 30V is detected for added user protection	●	●	●
General features			
Auto Power off to save batteries	●	●	●
Large display with backlight	●	●	●
Input Alert to warn for incorrect connections	●	●	●
Continuity	●	●	●

Insulation Specifications

Functions	1577	1587	1587T
Measurement range	0.1MΩ to 600MΩ	0.01MΩ to 2GΩ	0.01MΩ to 100MΩ
Test voltages	500V, 1000V	50V, 100V, 250V, 500V, 1000V	50V, 100V
Test voltage accuracy	+ 20%, -0%	+ 20%, -0%	+ 20%, -0 %
Insulation test current	1mA nominal	1 mA nominal	1 mA nominal
Auto discharge	Discharge time < 0.5s for C = 1 μF or less	Discharge time <0.5s for C = 1 μF or less	Discharge time <0.5s for C = 1 μF or less
Maximum capacitive load	Up to 1 μF load	Up to 1 μF load	Up to 1 μF load

Multimeter Specifications

Functions	Maximum	Max. resolution	1577	1587/1587T
Voltage DC	1000V	1 mV	± (0.2% + 2)	± (0.09% + 2)
Voltage AC	1000V	0.1mV	± (2% + 3)	± (2% + 3)
Current DC	400mA	0.01mA	± (1.0% + 2)	± (0.2% + 2)
Current AC	400mA	0.01mA	± (2% + 2)	± (1.5% + 2)
Resistance	50.0MΩ	0.1Ω	± (1.2% + 2)	± (0.9% + 2)
Capacitance	9999μF	1 nF	-	± (1.2% + 2)
Frequency	99.99kHz	0.01 Hz	-	± (0.1% + 1)
Temperature	-40°C to +537°C	0.1°C	-	± (1% + 10)

Battery life: Meter: 1000 hrs,
Insulation Test: >1000 tests

Weight: 0.55 kg
Three Year Warranty

Size (HxWxD):
203 mm x 100 mm x 50 mm

Recommended Accessories



C25
See page 130



i400
See page 126



TPAK
See page 132



L215
See page 123



TL238
See page 122

1503/1507 Insulation Testers



Fluke 1503

Fluke 1507

Truly portable insulation resistance testers

When you need a low cost solution to general purpose insulation testing look no further than the new Fluke insulation tester range. The Fluke 1507 and 1503 Insulation Testers are compact, rugged, reliable and easy to use.

The multiple test voltages on both models make them ideal for many troubleshooting, commissioning and preventive maintenance applications. Additional features like the remote probe save both time and money when performing tests.

Features

	1503	1507
User selectable test voltages for many applications	●	●
Additional test voltages 50V, 100V, 250V		●
Special remote control probe for easy and safe measurements	●	
Auto-discharge of capacitive voltage for added user protection	●	●
Live circuit detection prevents insulation test if voltage > 30 V is detected for added user protection	●	●
Save both time and money with Automatic calculation of Polarization Index and Dielectric Absorption Ratio		●
Auto Power off to save batteries	●	●
Large display with backlight	●	●
Continuity function (200 mA)	●	
Compare function (pass/fail) for fast repetitive tests		●

Specifications

Insulation specifications	1503	1507
Insulation test range	0.1 MΩ to 2 GΩ	0.01 MΩ to 10 GΩ
Test voltages	500 V, 1000 V	50 V, 100 V, 250 V, 500 V, 1000 V
Test voltage accuracy	+ 20 %, - 0 %	+ 20 %, - 0 %
Insulation test current	1mA nominal	1mA nominal
AC/DC Voltage measurement	600 V (0.1 V resolution)	600 V (0.1 V resolution)
Resistance measurement range	0.01 Ω to 20 kΩ	0.01 Ω to 20 kΩ
Auto discharge	Discharge time < 0.5 second for C = 1 μF or less	Discharge time < 0.5 second for C = 1 μF or less
Maximum capacitive load	Up to 1 μF	Up to 1 μF
Open circuit test voltage	> 4 V, < 8 V	> 4 V, < 8 V
Short circuit current	> 200 mA	> 200 mA

Battery life: Insulation Test: > 1000 tests
Size (HxWxD):
 203 mm x 100 mm x 50 mm

Weight: 0.55 kg
One Year Warranty



Included Accessories

- TP165x Remote Test Probe
- TL224 SureGrip Silicone Test Lead Set
- TP74 Lantern Tip Test Probe Set
- Alligator clips

Ordering Information

- Fluke 1503 Insulation Tester
- Fluke 1507 Insulation Tester

Fluke 1503/1507 Applications



Insulation test at a distribution panel



Wiring test in a small distribution box – all in one spot

Recommended Accessories



C101
See page 131



PAK
See page 132



TLK 225
See page 123



AC285
See page 122



L210
See page 133

1555/1550C Insulation Resistance Testers

FLUKE®

New



Fluke 1555

Fluke 1550C



Included accessories

Test Cables with Alligator Clips (red, black, green)
Infrared adapter with interface cable
FlukeView Forms Basic CD-ROM
AC Power Cord
Soft Carrying Case (base models only)
English Manual
Users Manual on CD-ROM
Quick Reference Card
Software License Agreement
Registration Card
FlukeView Forms Installation Guide
USB-IR Cable Installation Guide
IP67 Hard Case (kit only)
Certificate of Calibration (kit only)
Ruggedized Alligator Clips (kit and 1555 only)

Software specifications

Fluke ViewForms basic software requires a PC running Windows 2000, Windows XP and Windows Vista.

Optional Accessories

TL1550EXT 25 Foot Extended Test Lead Set

Ordering information

Fluke 1550C 5 kV Insulation Tester
Fluke 1555 10 kV Insulation Tester
Fluke 1550C/Kit 5 kV Insulation Tester Kit
Fluke 1555/Kit 10 kV Insulation Tester Kit

Digital insulation testing up to 10kV

The new 1555 and redesigned Fluke 1550C insulation resistance testers offer digital insulation testing up to 10kV, making them ideal for testing a wide range of high voltage equipment including switchgear, motors, generators and cables. Fluke insulation testers can now conduct the entire range of test voltages specified in IEEE 43-2000 with a best in class, 3-year warranty and CAT IV 600 V safety rating. With measurement storage and PC interface, the 1555 and 1550C are perfect tools for preventative or predictive maintenance programs designed to identify potential equipment failures before they occur.

- Test voltages up to 10 kV (1555) provides solutions for all applications
- CAT III 1000 V, CAT IV 600 V safety rating
- Voltage breakdown detection alerts the user that voltage is present and gives the voltage reading up to 600 V ac or dc for increased user safety

- Selectable test voltages in 50 V steps from 250 to 1000 V, and 100 V steps above 1000 V
- Measurements can be stored in up to 99 memory locations, with each location assigned a unique, user defined, label for easy recall
- Long battery life gives the user over 750 tests between charges
- Automatic calculation of Dielectric Absorption (DAR) and Polarization Index (PI) with no additional setup
- Guard system eliminates the effect of surface leakage current on high-resistance measurements
- Large digital/analog LCD for easy viewing
- Capacitance and leakage current measurement
- Ramp function for breakdown testing
- Resistance measurements up to 2TΩ
- Timer settings up to 99 minutes for timed tests
- 3-year warranty

Specifications

(Check the Fluke web for detailed specifications)

Test voltage (dc)	Range	Accuracy (± reading)
250 V	< 200 kΩ 200 kΩ to 5 GΩ 5 GΩ to 50 GΩ > 50 GΩ	unspecified 5 % 20 % unspecified
500 V	< 200 kΩ 200 kΩ to 10 GΩ 10 GΩ to 100 GΩ > 100 GΩ	unspecified 5 % 20 % unspecified
1000 V	< 200 kΩ 200 kΩ to 20 GΩ 20 GΩ to 200 GΩ > 200 GΩ	unspecified 5 % 20 % unspecified
2500 V	< 200 kΩ 200 kΩ to 50 GΩ 50 GΩ to 500 GΩ > 500 GΩ	unspecified 5 % 20 % unspecified
5000 V	< 200 kΩ 200 kΩ to 100 GΩ 100 GΩ to 1 TΩ > 1 TΩ	unspecified 5 % 20 % unspecified
10000 V (1555 only)	< 200 kΩ 200 kΩ to 200 GΩ 200 GΩ to 2 TΩ > 2 TΩ	unspecified 5 % 20 % unspecified
Bar Graph Range		0 to 1 TΩ & 0 to 2 TΩ (1555 only)
Insulation test voltage accuracy		-0 %, +10 % at 1 mA load current
Induced ac mains current rejection		2 mA maximum
Charging rate for capacitive load		5 seconds per μF
Discharge rate for capacitive load		1,5 s/μF
	Range	Accuracy
Leakage current measurement	1 nA to 2 mA	± (5% + 2 nA)
Capacitance measurement	0,01 uF to 15,00 μF	± (15% rdg + 0,03 μF)
Timer	Range	Resolution
	0 to 99 minutes	Setting: 1 minute Indication: 1 second
Live circuit warning	Warning range	Voltage accuracy
	30 V to 660 V ac/dc, 50/60 Hz	± (15% + 2 V)

Temperature (operating):

-20 °C to 50 °C (-4 °F to 122 °F)

Temperature (storage):

-20 °C to 65 °C (-4 °F a 149 °F)

Humidity: 80 % to 31 °C decreasing linearly to 50 % at 50 °C

Enclosure sealing: IP40

Altitude: 0 to 2000 m

Power: 12 V lead-acid rechargeable battery, Yuasa NP2.8-12

Dimensions: 170 mm x 242 mm x 330 mm

Weight: 3,6 kg (7,94 lb)

3-year warranty

1620 Series Earth Ground Testers GEO

FLUKE®



Fluke 1623



Fluke 1625



Fluke 1625 kit

Included accessories

Fluke 1623: Protective holster, 2 test leads, 2 alligator clips, users manual

Fluke 1623 Kit: same as above plus stake/reel Set 4 pole and selective/stakeless clamp set

Fluke 1625: Protective holster, 2 test leads, 2 alligator clips, users manual

Fluke 1625 Kit: same as above plus stake/reel set 4 pole and selective/stakeless clamp set

Ordering information

Fluke 1623	Basic GEO Earth Ground Tester
Fluke 1623 Kit	Basic GEO Earth Ground Tester Kit
Fluke 1625	Advanced GEO Earth Ground Tester
Fluke 1625 Kit	Advanced GEO Earth Ground Tester Kit

Advanced technology for all your earth ground testing applications

The new Fluke 1620 Series Earth Ground Testers not only measure ground resistance using the classic 'fall of potential test' but also enable time saving testing using the 'selective' and 'stakeless' methods. 'Selective' testing does not require the electrode under test to be disconnected during the measurement, thus increasing safety. The simple 'stakeless' method quickly checks ground connections using two current transformers (probes) clamped around the ground conductor under test. Offering 'one-button' simplicity, the 1623 is an all-in-one earth ground tester, while the 1625 has extra versatility for more demanding applications.

Earth ground resistance and soil resistivity should be measured when:

- Designing earth ground systems
- Installing new ground system and electrical equipment
- Periodically testing ground and lightning protection systems
- Installing large electrical equipment such as transformers, switchgears, machines, etc.

Features

	1623	1625
One-button measurement concept	●	
3- and 4-pole earth ground measurement	●	●
4-Pole soil resistivity testing	●	●
2-Pole resistance measurement AC		●
2-and 4-pole resistance measurement DC		●
Selective testing, no disconnection of ground conductor (1 clamp)	●	●
Stakeless testing, quick ground loop testing (2 clamps)	●	●
Measuring frequency 128 Hz	●	
Earth impedance measurement at 55 Hz		●
Automatic frequency control (AFC) (94 - 128 Hz)		●
Measuring voltage switchable 20/48V		●
Programmable limits, settings		●
Continuity with buzzer		●
Dust/water resistance	IP56	IP56
Safety rating	CAT II 300 V	CAT II 300 V

Specifications

(Check the Fluke web for detailed specifications)

	1623	1625
Resistance ranges	0 to 20 kΩ	0 to 300 kΩ
Operating error	± 5%	± 5%
Test voltage	48 V	20 / 48 V
Short circuit current	> 50mA	250 mA

Battery type: 6 x AA alkaline cells

Size (HxWxD): 110 mm x 180 mm x 240 mm

Weight - 1623 Geo: 1.1 kg (including batteries)

1625 Geo: 1.1 kg (including batteries)

Two Year Warranty

Recommended Accessories

EI-1623 Selective/stakeless clamp set for 1623	EI-1625 Selective/stakeless clamp set for 1625	ES-162P3 Stake/reel set for 3 pole measurements	ES-162P4 Stake/reel set for 4 pole measurements	EI-162BN 320mm Split core transformer for selective measurements on high voltage pylons

1621 Earth Ground Tester



Fluke 1621

Handheld earth ground testing for mobile use

The Fluke 1621 is an easy-to-use earth ground tester. The first line of defense in detecting reliable ground connections, the unit features basic ground testing methods including 3-pole Fall-of-Potential as well as 2-pole ground resistance. Its convenient size, rugged holster, and large, clear LCD display make it an ideal field earth tester, for most work environments. With a simple user interface and intuitive functionality, the Fluke 1621 is a handy tool for electrical contractors, utility test engineers, and earth ground specialists.

Features

- 3-pole Fall-of-Potential earth testing for basic measurements
- 2-pole resistance measurements for added versatility
- Easily capture values with single-button operation
- Ensure accurate measurements with automatic 'noise' voltage detection
- Hazardous voltage warning offers increased user protection
- Clearly read and record data with a large, backlit display
- Rugged holster and design for tough work environments
- Portable size allows for easy transportation
- Instantly be alerted to measurements outside of your set limit, when you use the adjustable limit setting
- Safety rating CAT II 600 V

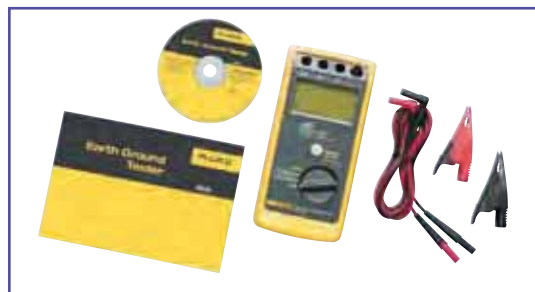

Specifications

(Check the Fluke web for detailed specifications)

	1621
Resistance range	0.15 Ω to 2 kΩ
Basic accuracy	± 6% of measured value + 5D
Operating error according EN61557	± 18% of measured value + 5D
Test voltage	23 to 24 V AC
Short circuit current	> 50 mA AC

Battery type: 1 x 9 V alkaline (LR61)
Size (HxWxD): 216 mm x 113 mm x 54 mm
Weight: 0.850 kg
Two Year Warranty

Included accessories

Two measuring leads with alligator clips - 2 m, protective holster, users manual, CD-ROM

Ordering information

Fluke 1621 Earth Ground Tester

Recommended Accessories



GEO CABLE-REEL 25M
Ground Earth Cable Reel
25 M Wire



GEO CABLE-REEL 50M
Ground Earth Cable Reel
50 M Wire



GEO EARTH STAKE
Ground Earth Stake



ES-162P3
Stake/reel set for 3 pole
measurements

1630 Earth Ground Clamp Meter

FLUKE®



Fluke 1630

Fast and easy earth ground loop testing

The Fluke 1630 earth ground clamp meter simplifies ground loop testing and enables non-intrusive leakage current measurement. The ground loop testing is also known as “stakeless” earth ground testing. To carry out the measurement there is no need for placing earth stakes and disconnecting the earth system from the electrical installation. The Fluke 1630 combines the two current clamps needed to perform the stakeless ground loop test in one compact and easy to use instrument.

- Ground loop resistance testing without any disconnection or additional earth stakes
- Earth ground leakage current measurement for system troubleshooting
- True RMS AC current measurement range up to 30 A

- Rapid evaluation of continuity without disconnection and audible HI/LO alarm
- Display-HOLD function to freeze measurements
- Recording function for automatic storage of measured values, which can be recalled later on the LCD display
- Automatic self calibration ensures correct measurement every time

The Fluke 1630 is ideally suited for the following applications:

- Ground loop checks on any earthing system
- Continuity tests on earth bonding circuits and connections
- Inspection of lightning protection systems
- Leakage current measurement for troubleshooting on earth ground systems

Specifications

(Check the Fluke web for detailed specifications)

	Range	Max. resolution
Resistance	0.025 to 1500 Ω	0.002 Ω
Continuity buzzer	< app. 40 Ω	
Leakage current	0.2 to 1000 mA	0.001 mA
Current	0.2 to 30 A	0.01 A



Weight: 0.64 kg
Conductor Size: 35 mm approx.
Size (HxWxD): 257 mm x 100 mm x 47 mm
Battery type: 9 V IEC 6 LR 61
Two Year Warranty

Ground resistance measurements principle

Ground resistance measurements principle

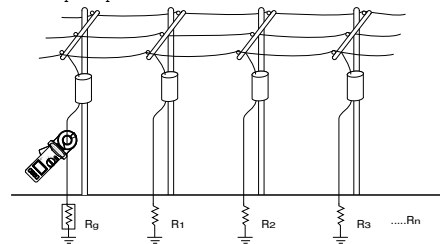

Equivalent circuit diagram

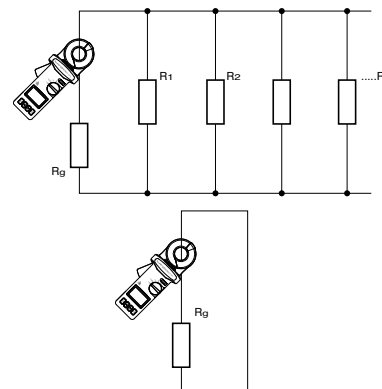

Included Accessories

Rugged carrying case with belt, Resistance test loop, 9 V battery, Operating instructions.

Ordering Information

Fluke 1630 Earth Ground Clamp Meter

Installation Testers/ Portable Appliance Testers

Our multifunction testers have redefined the standards for ease-of-use. With new features like the fast, high current loop test, RCD Type B compatibility, extended memory, and the fact they are designed for ensuring fixed wiring installed according to IEC 60364, they perform all tests required to verify safety. Our Portable Appliance Testers verify the safety and operation of portable appliances, and are designed for 'one-touch' operation and a fast throughput."



1650 Series Multifunction Installation Testers

FLUKE®

New
RCD Type B Compatibility



Fluke 1654B



Fluke 1653B



Fluke 1652C



BS7671 17th Edition IEE Wiring Regulations IEC 60364.6.61, HD 384

Included Accessories

- 6 AA Cell batteries
- C1600 Hard carrying case
- Zero Adapter
- Mains test cord
- TL165X STD Standard Test Lead Set
- TL165/UK Fused Test Lead Set (UK only)
- Padded carrying strap
- Quick reference guide
- TP165X Remote control probe and lead
- Users manual on CD-ROM

Ordering Information

- Fluke 1652C Multifunction Installation Tester
- Fluke 1653B Multifunction Installation Tester
- Fluke 1654B Multifunction Installation Tester

Check the Fluke website for the various software modules

Extra functionality, faster testing, and as rugged as ever

Safer, easier installation testing. The new 1650 Series builds on the rugged reputation of the earlier 1650 Series, only it's re-designed to meet your need for more productive test tools. With new features like the fast, high current loop test (including a non-trip test) and a variable RCD trip current setting, accuracy is even better and the test cycle even faster. And with the addition of a unique zero adapter accessory for accurate mains test lead compensation, the 1650 Series continues to set the standard in installation testers. The 1650 Series testers verify the safety of electrical installations in domestic, commercial and industrial applications. They can ensure that fixed wiring is safe and correctly installed to meet the requirements of IEC 60364, HD 384 and BS 7671 17th Edition wiring regulations.

1654B - The complete tester for advanced users

This is the instrument that has it all, in a word: it's complete. From all the test functions you need to in-built memory

for documenting results. This makes it the complete solution for professionals, especially contractors, everyone who would want to have the best tool available and always understands (or know) how to use.

1653B - The ideal tester for professional trouble-shooters

This is the instrument that is indeed ideal for professional users due to its additional functionality. It is also ideal since even though it has high-end features, it is still easy to use – even after longer periods of non-use; because operating it is intuitive and not forgotten easily.

1652C - The everyday tester, for every electrical installer

This is the instrument that can be used every single day (day in, day out), and covers all the basic needs. It is the preferred tester for every front-line electrician/installer.

Features

Measurement Function	1652C	1653B	1654B
Voltage & Frequency	•	•	•
Insulation Resistance	•	•	•
Continuity & Resistance	•	•	•
Loop & Line Resistance	•	•	•
Loop & Line Resistance—mΩ resolution			•
Prospective Earth Fault Current (PEFC/IK)	•	•	•
Prospective Short-Circuit current (PSC/IK)	•	•	•
RCD switching time		•	•
RCD tripping level	ramp test	ramp test	ramp test
RCD variable current	•	•	•
Automatic RCD test sequence	•	•	•
Test pulse current sensitive RCDs (Type A)	•	•	•
Test smooth dc sensitive RCDs (Type B)			•
Earth Resistance		•	•
Phase Sequence Indicator	•	•	•
Other Features			
Self-test	•	•	•
Illuminated Display	•	•	•
Memory, Interface			
Memory		•	•
Extended Memory			•
Computer Interface		•	•
Time and date (When used with FlukeView software)		•	•
Software		•	•
Included Accessories			
Hard case	•	•	•
Remote control probe	•	•	•
Zero Adapter	•	•	•

Recommended Accessories

See also page 48 for more details



TLK290



MTC1363 (UK)



MTC77 (Europe)



ES165X 1653B & 1654B



FVF-SC2

1650 Series Multifunction Installation Testers

FLUKE®

Extra functionality, faster testing, and as rugged as ever

Specifications

(Check the Fluke web for detailed specifications)



Slim probe design

Thanks to its slim probe with integral test button, you can safely make one-handed measurements on hard to reach points, while keeping your eyes on the panel. This remote probe is powered by the tester so always operable (does not require additional batteries!).

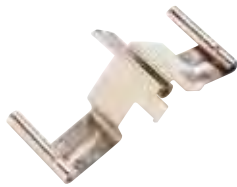

Zero Adaptersign

For easy, always reliable and accurate compensation for test leads and mains cords. This adapter can be used for all different kind of mains plugs as well as test accessories like probes, alligator clips etc.



Complete kit

All 1650 models are equipped with detachable leads that can be replaced in case of damage or loss. A durable hard case will protect your instrument in tough field conditions.

AC Voltage Measurement					
Range	Resolution	Accuracy	Input Impedance	Overload Protection	
500 V	0.1 V	50 Hz - 60 Hz ± (0.8% + 3 digits)	3.3 MΩ	660 Vrms	
Continuity Testing					
Range (autoranging)	Resolution	Test Current	Open Circuit Voltage	Accuracy	
20 Ω	00.1 Ω	> 200 mA	> 4 V	± (1.5%+3 digits)	
200 Ω	0.1 Ω				
2000 Ω	1 Ω				
Insulation Resistance Measurement					
Model	Test Voltage	Insulation Resistance Range	Resolution	Test Current	Accuracy
1653B / 1654B	50 V	10 kΩ to 50 MΩ	0.01 MΩ	1 mA @ 50 kΩ	± (3%+ 3 digits)
1653B / 1654B	100 V	20 kΩ to 100 MΩ	0.01 MΩ 0.1 MΩ	1 mA @ 100 kΩ	± (3%+ 3 digits)
1653B / 1654B 1653B / 1654B	250 V	20 kΩ to 200 MΩ	0.01 MΩ 0.1 MΩ	1 mA @ 250 kΩ	± (1.5%+ 3 digits)
1653B / 1654B 1652C	500 V	20 MΩ 200 MΩ	0.01 MΩ 0.1 MΩ	1 mA @ 500 kΩ	± (1.5%+ 3 digits) + 10%
1653B / 1654B 1652C	1000 V	20 MΩ 200 MΩ 1000 MΩ	0.1 MΩ 1 MΩ	1 mA @ 1 MΩ	± (1.5%+ 3 digits) + 10%
Loop Impedance Measurement					
Range	Resolution	Accuracy [1]			
10 Ω	0.001 Ω	Hi Current mΩ mode: ± (2 % + 15 digits) No Trip mode: ± (3 % + 6 digits)			
20 Ω	0.01 Ω	Hi Current mode: ± (2 % + 4 digits) No Trip mode: ± (3 %)			
200 Ω	0.1 Ω	Hi Current mode: ± (2 %)			
2000 Ω	1 Ω	±6 % [2]			

Notes
[1] Valid for resistance of neutral circuit <20 Ω and up to a system phase angle of 30°. Test leads must be zeroed before testing.
[2] Valid for mains voltage >200 V.

PFC, PSC Test	
Range	1000A / 10kA(50kA)
Resolution and Units	1A / 0.1kA
Accuracy	Determined by accuracy of loop resistance and mains voltage measurements

Computation
Prospective Earth Fault Current (PEFC) or Prospective Short Circuit Current (PSC) determined by dividing measured mains voltage by measured loop (L-PE) resistance or line (L-N) resistance, respectively.

RCD Testing				
RCD Type [6]		Model 1652C	Model 1653B	Model 1654B
AC [1]	G [2]	•	•	•
AC	S [2]	•	•	•
A [4]	G	•	•	•
A	S	•	•	•
B [5]	G			•
B	S			•

Notes
[1] AC - Responds to ac
[2] G - General, no delay
[3] S - Time delay
[4] A - Responds to pulsed signal
[5] B - Responds to smooth dc
[6] RCD test inhibited for V >265 ac
RCD tests permitted only if the selected current, multiplied by earthing resistance, is <50 V.

Tripping Time Test (ΔT)			
Current Settings	Multiplier	Test Current Accuracy	Trip Time Accuracy
10, 30, 100, 300, 500, 1000 mA, VAR	x 1/2	+ 0% - 10%	± (1% Reading + 1 digit)
10, 30, 100 mA	X 5	+ 10% - 0%	± (1% Reading + 1 digit)

Tripping Current (Ramp) Test				
Current Range	Step Size	Dwell Time		Measurement Accuracy
		Type G	Type S	
30 % to 110 % of RCD rated current [1]	10 % of I Δ N [2]	300 ms/step	0 ms/step	±5 %

Notes
[1] 30 % to 150 % for Type A Δ N >10 mA
30 % to 210 % for Type A Δ N =10 mA
20 % to 210 % for Type B
Specified trip current ranges (EN 61008-1):
50 % to 100 % for Type AC
35 % to 140 % for Type A (>10 mA)
35 % to 200 % for Type A (≤10 mA)
50 % to 200 % for Type B
[2] 5% for Type B

Earth Resistance Test (RE) – Fluke 1654B and 1653B only		
Range	Resolution	Accuracy
200 Ω	0.1 Ω	± (2% + 5 digits)
2000 Ω	1 Ω	± (3.5% + 10 digits)

Battery type: Alkaline supplied, usable with 1.2 V NiCd or NiMH rechargeable batteries

Size (HxWxD): 100 mm x 250 mm x 125 mm

Weight: 1.3 kg
Three Year Warranty

6000 Series PAT Testers



Fluke 6200



Fluke 6500

Also available with European mains socket.



Versatile PAT testing at your fingertips

The Fluke 6200 and 6500 PAT testers verify the electrical safety and operation of portable appliances in accordance with relevant guidelines and regulations. With powerful auto test capabilities and simplified controls they increase the number of tests you can perform per day without compromising results.

A choice of automatic and manual PAT testers

Both models perform all the tests required for class I and class II appliances. For manual testing and low volume applications, choose the cost-effective 6200 PAT model. If you need a more powerful instrument to test large numbers of appliances, the 6500 is the right choice.

Fluke simplifies portable appliance testing

- Compact and lightweight... Efficient to work with and easy to carry around- and has extra space in the hard case for accessories.
- One touch simplicity... Pre-set and user-definable test routines are initiated from a single button - to speed up test procedures and save you time on site.
- A better way of working... Rapid data entry via a QWERTY keyboard (or optional Fluke barcode scanner) and fast data transfer from the main memory or the Compact Flash memory card (6500).

6200

- Dedicated key for each test for 'one-touch' testing
- Pre-set pass/fail levels to save time
- Large backlit display for easy reading

6500

- As 6200 but also with:
- Integral QWERTY keyboard for rapid data entry
 - Slot for Compact Flash memory card for back-up data storage and transfer to PC
 - Pre-set, auto-test sequences for user convenience

Features

Measurement functions	6200	6500
L N Mains Volts	●	●
Outside Limits Indicators	●	●
Null out facility for earth bond lead	●	●
Protective Earth Resistance PE (200mA)	●	●
Protective Earth Resistance PE (25A)	●	●
Insulation 500V dc	●	●
Protective Earth Conductor Current	●	●
Touch Current	●	●
Substitute Leakage Current	●	●
Appliance Power kVA	●	●
Appliance Load Current	●	●
Seven Segment Custom LCD	●	●
Graphical LCD		●
Back Light	●	●
Compact Flash Card receptacle		●
Serial Port - Printing / Downloading	●	●
External printer output	●	●
Front Panel QWERTY Key pad		●
IEC Lead Test	●	●
Auto-testing		●
Pass / Fail Level Programmable Indicators		●
Data Storage		●
Limited Data Storage	●	
Polarity Checks	●	●
Graphical Help Menu On Line		●
Programme Mode		●
Real time clock		●
Front panel results management		●
230V BS1363 Test socket / 230V Mains BS1363 input power plug	●	●

Included Accessories

Test lead, Test probe, Crocodile clip, Mains cord

Ordering Information

Fluke 6200 PAT Tester
Fluke 6500 PAT Tester

Not available in all countries

6000 Series PAT Testers



Separate hard case

The compact Fluke PAT testers are supplied with a hard carrying case that not only offers protection during transit but also includes extra storage space for accessories and other tools. They're extremely light, weighing approximately 3 kg (without case) and have integral carrying handles for extra convenience.



Special PAT Kit

If you need a complete PAT tester solution, a purpose made kit is available.

Fluke 6500/UK Kit Contains:

- 6500, Mainframe
- EXTL 100, Extension lead test adaptor
- SP Scan 15, Barcode scanner
- Fluke PowerPat Plus
- Pass 560R, Appliance pass labels
- Fail 100S, Appliance fail labels APP 1000, Barcode appliance number labels

(Kit contents may vary per country)

Display Screens

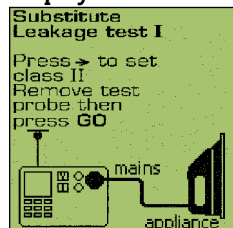

Substitute Leakage Current Test

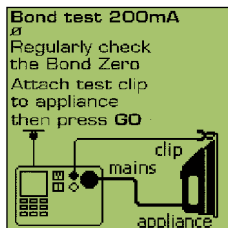

Earth Bond Test (RPE)

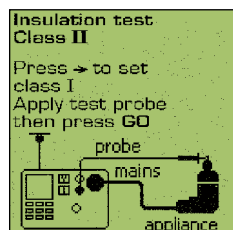

Insulation Test (RISO)

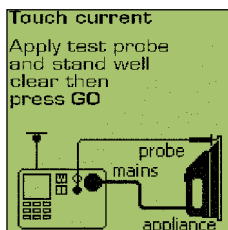

Touch Current Test

Specifications

The accuracy specification for the display range is defined as $\pm (\% \text{reading} + \text{digit counts})$ at $23^\circ\text{C} \pm 5^\circ\text{C}$, $\leq 75\%$ RH. Between 0°C and 18°C and between 28°C and 40°C , accuracy specifications may degrade by $0.1 \times$ (accuracy specification) per $^\circ\text{C}$. The measurement range meets the service operating errors specified in EN61557-1: 1997, EN61557-2: 1997, EN61557-4: 1997.

Power-on Test	
The test indicates reversed L-N, missing PE, and measures the mains voltage and frequency.	
Display Range	90 V to 264 V
Accuracy at 50 Hz	$\pm (2\% + 3 \text{ counts})$
Resolution	0.1V (1V - model 6200)
Input Impedance	$> 1 \text{ M}\Omega // 2.2 \mu\text{F}$
Maximum Input Mains Voltage	300 V

Earth Bond Test	
Display Range	0 to 19.99 Ω
Accuracy (after Bond Test zeroing)	$\pm (5\% + 4 \text{ counts})$
Resolution	0.01 Ω
Test Current	200 mA AC - 0% + 40% into 1.99 Ω 25 A AC $\pm 20\%$ into 25 m Ω at 230 V
Open Circuit Voltage	$> 4 \text{ V AC}$, $< 24 \text{ Vac}$
Bond Test zeroing	can subtract up to 1.99 Ω

Insulation Test (Riso)	
Display Range	0 to 299 M Ω
Accuracy	$\pm (5\% + 2 \text{ counts})$ from 0.1 to 50 M Ω $\pm (10\% + 2 \text{ counts})$ from 50 to 299 M Ω
Resolution	0.01 M Ω (0 to 19.99 M Ω) 0.1 M Ω (20 to 199.9 M Ω) 1 M Ω (200 to 299 M Ω)
Test Voltage	500 V DC - 0% + 25% at 500 k Ω load
Test Current	$> 1 \text{ mA}$ at 500 k Ω load, $< 15 \text{ mA}$ at 0 Ω
Auto discharge time	$< 0.5 \text{ s}$ for 1 μF
Max. Capacitive Load	Operational up to 1 μF

Touch Current Test	
Display Range	0 to 1.99 mA ac
Accuracy	$\pm (4\% + 2 \text{ counts})$
Resolution	0.01 mA
Internal Resistance (via probe)	2 k Ω
Measuring method	Probe
The appliance under test is energized at mains potential.	

Substitute Leakage Current Test	
Display Range	0 to 19.99 mA ac
Accuracy	$\pm (5\% + 5 \text{ counts})$
Resolution	0.01 mA
Test Voltage	35 V AC $\pm 20\%$
Operational Error	10%

Load/Leakage Test: Load Current	
Display Range	0 to 13 A
Accuracy	$\pm (4\% + 2 \text{ counts})$
Resolution	0.1 A
The appliance under test is energized at mains potential	

Load/Leakage Test: Load Power	
Display Range	0 to 999 VA 1.0 kVA to 3.2 kVA
Accuracy	$\pm (5\% + 3 \text{ counts})$
Resolution	1 VA (0 to 999 VA) 0.1 kVA (1.0 kVA to 3.2 kVA)
The appliance under test is energized at mains potential	

Load/Leakage Test: Leakage Current	
Display Range	0.25 to 19.99 mA
Accuracy	$\pm (4\% + 4 \text{ counts})$
Resolution	0.01 mA
The appliance under test is energized at mains potential	

PELV Test	
Accuracy at 50 Hz	$\pm (2\% + 3 \text{ counts})$
Overload protection	300 Vrms
Warning threshold	25 Vrms

Size (HxWxD): 200 mm x 275 mm x 100 mm
Weight: 3 kg
Two Years Warranty

Recommended Accessories

See also page 48 for more details



Fluke PowerPat Plus software



SP1000-02 Mini printer



SP-SCAN-15 Barcode scanner (6500 Fluke only)



BDST3 Snap Tags Cable Tie



PASS Appliance 560R Pass Labels

1650 Series/6000 Series Accessories

FLUKE®

Accessories for Fluke 1650 Series Installation Testers



ES165X Earth Spike Test Kit (Fluke 1653B and 1654B)

Earth Spike Test kit contents:

- Auxiliary earth probes
- Test connection leads and crocodile clips
- Purpose-made carry case



FVF-SC2 Fluke ViewForms Software (Fluke 1653B)

To address the increasing demands for reporting and documentation, Fluke presents FlukeView Forms documenting software. Download the data from the Fluke 1653B and create an easy report. The Fluke ViewForms Software also supports other Fluke tools. See page 132.



TLK 290 Test Probe Kit

- Kit includes three flexible socket probes and a large alligator clip
- To be used on three phase sockets
- Probes have flexible width test points that fit securely in 4 to 8 mm sockets
- CAT III 1000 V, 8 A



MTC1363

MTC77

Mains Test Cord for 1650B series

MTC1363

UK plug

MTC77

Schuko plug

Accessories for Fluke 6500 Series Portable Appliance Testers



PASS560R Appliance Pass Labels

Quantity 500



APP1000/APP2000 Bar Code Appliance Number Labels

APP1000: Labels numbered 0001-1000

APP2000: Labels numbers 1001-2000

Label number >2000 on request



BDST3/BDST4 Snap Tags

BDST3: Cable Tie

BDST4: Clip On

Quantity 20. Without labels.

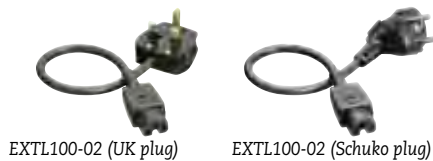

EXTL100-02 (UK plug)

EXTL100-02 (Schuko plug)

EXTL100 Extension Lead Test Adaptor

Adaptor for testing extension leads. Allows the earth test lead to be connected to the extension leads to perform insulation and earth bond tests.



SPScan15 Barcode Scanner

Easy to use, low current, intelligent barcode reader. SPScan15 can be used to scan barcodes attached to curved surfaces or where actual contact with the barcode surface is difficult.



SP1000 Mini Printer

Without using any additional software the SP1000 can be used to directly printout stored test records on to thermal paper. The printer is compact and easily transported and is ideal for test professionals who need to issue an immediate written account of work carried out. The printer is powered by a rechargeable battery and comes complete with mains charger and RS232 Printer Lead.

SP1000 Paper

Replacement thermal paper for the SP1000 Mini Printer

Fluke DMS software for 1650/6000 Series



The Fluke DMS (Data Management Software) is an efficient program for administration and reporting of installation tests in compliance with EN 60364, DIN VDE 0100/0105, BS7671 17th edition wiring regulation and appliance tests in compliance with DIN VDE 0701/0702, ÖVE E 8701.

DMS 0100/INST Software for Installation Tester Fluke 1653B and 1654B

Supporting reports for Austria, Germany, UK, Switzerland, Netherlands

DMS 0702/PAT Software for Portable Appliance Tester Fluke 6500

Supporting reports for Austria, Germany, UK, Netherlands

DMS COMPL PROF Software for the Fluke 1654B, 1653B and Fluke 6500

Supporting reports for Austria, Germany, UK, Switzerland, Netherlands

Digital Thermometers

For troubleshooting systems where temperature is a critical symptom, our digital thermometers provide you with laboratory accuracy wherever you need it. We offer a choice of non-contact, laser-guided infrared thermometers for safely getting at hard-to-reach, electrically live or particularly hot targets, and contact thermometers with a full range of thermocouple probes.



Infrared Thermometer Selection Guide



Infrared Thermometer Selection Guide	Fluke 60 Series		Fluke 560 Series		Fluke 570 Series	
	Fluke 61	Fluke 62	Fluke 561	Fluke 566	Fluke 568	Fluke 572
Temperature range	-18 to 275 °C	-30 to 500 °C	-40 to 550 °C	-40 to 650 °C	-40 to 800 °C	-30 to 900 °C
Accuracy	2%	1.5%	1%	1%	1%	0.75%
Response time	< 500 mSec	< 500 mSec	< 500 mSec	< 500 mSec	< 500 mSec	< 250 mSec
Optical resolution	8:1	10:1	12:1	30:1	50:1	60:1 (50:1 with close focus)
Close focus model available						●
Recommended distance to spot	Up to 2 m	Up to 2 m	Up to 2.5 m	Up to 4.5 m	Up to 7.5 m	300 mm (with close focus) up to 10.5 m
Laser sighting	single-point laser	single-point laser	single-point laser	single-point laser	single-point laser	3-point laser
Adjustable emissivity			●	●	●	●
MIN/MAX readings		-/●	●	●	●	●
AVG readings			●	●	●	●
DIF readings			●	●	●	●
Backlit LCD	●	●	●	●	●	●
Bar graph display						●
Audible Hi/Lo alarm						●
Visible Hi/Lo alarm						●
Includes contact probe			●	●	●	●
Probe input (types)			Type K Thermocouple	Type K Thermocouple	Type K Thermocouple	Type K Thermocouple
Data logging (number of measurements)				20 points	99 points	100 points
PC interface					USB	RS232
Compatible with FlukeView Forms software					●	●
See catalog page	52	52	54	53	53	51

Recommended Applications



Contact thermometers
For our complete range of contact thermometers, see page 55.



Plant/facilities maintenance
Preventive and predictive maintenance
Energy audits
Vehicle and fleet maintenance
Faulty electrical/circuit connections
Petrochemical/hazardous locations
Motors, pumps and bearings



Heating/ventilation/air conditioning/refrigeration
Leaky ductwork
Thermostats
Temperature balancing
Steam distribution systems
Compressor lines

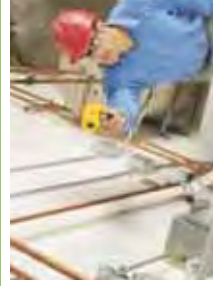

Manufacturing processes
Molding temperature measurement
Printing, paper and converting
Thermofforming plastics
Electronics
Paint curing/drying
Food
Chemical and pharmaceutical



Safety and protection
Fire localization
Hazardous materials
Faulty ballasts
Search and rescue
Smoldering embers
Equipment maintenance

570 Series Precision Infrared Thermometers

FLUKE®



Fluke 574



Fluke 572

Measure temperature with ease and precision

The Fluke 570 series are the most advanced IR non-contact thermometers, and are ideal for predictive and preventative maintenance applications. Offering a broad temperature range and a true dimension laser sighting system for precise targeting resulting in more accurate measurements. When requiring analysis and documentation use the 100-point data logging and software for graphing and analysis. From close-up electrical connections, to far-distance room balancing checks, the Fluke 570 series can take IR temperature measurements with ease and precision.

- Enhanced optics allows measurements of smaller objects from farther away
- True Dimension™ three-dot laser sighting system highlights the true diameter of measurement spots at all distances
- Adjustable emissivity setting and 30 pre-set common material values for more accurate measurements
- 100 data point memory for storage of measurements (Fluke 574).

Features

	572	574
Temperature range	-30 to 900°C	
Optical resolution	Standard: 60:1 Close focus: 50:1	
3 dot laser beam for accurate targeting	●	●
Adjustable emissivity	●	●
Bar graph display	●	●
Backlit LCD display	●	●
Use selectable °C or °F	●	●
Audible and visible Hi/Lo Alarm	●/●	●/●
MIN/MAX	●	●
AVG/DIF readings		●
Datalogging (number of measurements)		100
PC interface		RS232

Specifications

	572	574
Temperature range	-30 to 900°C	
Response time	250ms (95 % of reading)	
Resolution	0.1°C of reading up to 900°C	
Repeatability	±0.5% of reading or ±1°C*	
Accuracy: (assumes ambient operating temperature of 23 °C to 25 °C)	±0.75% of reading, ±0.75°C *	
Typical distance to target	10,5 m	
Emissivity	Digitally adjustable from 0.10 to 1.0 by 0.01	

*whichever is greater.

Battery Life: 10 hours typical
Weight: 0.480 kg
Size (HxWxD): 200 mm x 170 mm x 55 mm
Two years warranty

Included Accessories

Fluke 572: Hard case, 2 batteries
 Fluke 574: Hard case, 2 batteries, Thermocouple K probe, 220V power supply, IRGraph software, RS232 cable

Ordering Information

Fluke 572 Precision Infrared Thermometer
 Fluke 574 Precision Infrared Thermometer
 Fluke 572CF Precision Infrared Thermometer with close focus option
 Fluke 574CF Precision Infrared Thermometer with close focus option

Recommended Accessories



AN5
Analog data cable

60 Series Infrared Thermometers

FLUKE®



Fluke 63



Fluke 62



Fluke 61

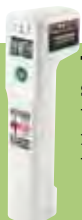

The Fluke FoodPro™ thermometer series provide advanced temperature measurement solutions for the foodservice industry. Check the Fluke web for more information.

Point, press and read temperature

The Fluke 60 Series non-contact thermometers are the ideal professional diagnostic tools for quick and accurate temperature measurements. These handheld tools are ideal for measuring surface temperatures of rotating, hard-to-reach, electricity live or dangerously hot targets like electrical motors and – panels, and heating and ventilation systems. The laser sighting system guides measurements to the right target and in less than a second, the large temperature display provides a readout of the surface temperature.

The 60 Series IR thermometers feature:

- Laser guided sighting system for easy targeting with 1% accuracy
- Up to 12:1 optical resolution
- Backlit display for easy reading in the dark
- Temperatures up to 535°C

Features

	61	62	63
Form factor	Flat grip	Pistol grip	Pistol grip
Temperature range	-18 to 275°C	-30 to 500 °C	-32 to 535°C
Optical resolution	8:1	10:1	12:1
Laser beam for accurate targeting	●	●	●
Backlit LCD display	●	●	●
Use selectable °C or °F	●	●	●
Min/max/avg/dif readings		Max	Max

Specifications

	61	62	63
Range	-18 to 275°C	-30 to 500 °C	-32 to 535 °C
Response time	< 500ms	< 500ms (95 % of reading)	≤ 0.5 second
Resolution	0.2 °C	0.2 °C	0.2 °C
Repeatability (% of reading)	± 2% or ± 2 °C*	± 0.5% or ≤ ± 1 °C*	± 0.5% or ≤ ± 1 °C*
Accuracy: (assumes ambient operating temperature of 23°C)	For targets at: -18 to -1°C: ± 3°C -1 to 275°C: ± 2% of reading or ± 2°C	For targets at: 10 °C to 30 °C: ± 1 °C ± 1.5% of reading or ± 1.5°C whichever is greater over the balance of the range	For targets at: -32 to -26°C: ± 3°C -26 to -18°C: ± 2.5°C -18 to 23°C: ± 2°C 23°C -510°C: ± 1% of reading or ± 1°C* For targets above 510°C: ± 1.5% of reading
Typical distance to target	Up to 1m	Up to 1.5 m	Up to 2 m
Emissivity	Fixed at 0.95	Pre-set to 0.95	Fixed at 0.95

* whichever is greater

Battery Life:

Fluke 63: 10 hours with laser and backlight on
Fluke 62: 12 hours with laser and backlight on
Fluke 61: 12 hours with laser and backlight on

Weight:

Fluke 63: 0.320 kg
Fluke 62: 0.200 kg
Fluke 61: 0.227 kg

Size (HxWxD):

Fluke 63: 200 mm x 160 mm x 55 mm
Fluke 62: 152 mm x 101 mm x 38 mm
Fluke 61: 184 mm x 45 mm x 38 mm

Fluke 62: 2 years warranty
Other models: one year warranty

Included Accessories

Fluke 61: 9V Battery
Fluke 62: 9V Battery, storage holster
Fluke 63: Hard carrying case, 9V batteries

Ordering information

Fluke 61 Infrared Thermometer
Fluke 62 Mini Infrared Thermometer
Fluke 63 Infrared Thermometer
Fluke 62/322/1AC-E (see page 5)
Fluke T5-600/62/1AC (see page 5)
Fluke FP FoodPro™ Food Safety Thermometer
Fluke FP Plus FoodPro™ Plus Food Safety Thermometer

Kits



Fluke 62/322 kit

T5-600/62/1AC-E

Recommended Accessories



C23
See page 130

H6
See page 131

566 and 568 Multipurpose Thermometers

FLUKE®



Fluke 566

Fluke 568

The two-in-one infrared and contact thermometer with an innovative graphical display

With a straight-forward, menu-driven user interface and graphical display, the Fluke 566 and 568 multipurpose thermometers make even complex temperature measurements easy. Quickly navigate and adjust emissivity, start data logging, or turn on and off alarms, with just a few pushes of a button. For added convenience, both rugged handheld thermometers combine contact and non-contact temperature measurement capability, providing a total temperature measurement solution for any service and maintenance program.

- Easily access advanced features with the soft-key buttons and graphical display
- Measure smaller targets from farther away using the IR thermometer
- Adjustable emissivity and built-in table of common materials for higher IR accuracy
- Quickly identify problems with the MIN, MAX, AVG, and DIF functions
- 2-color flashing alarm alerts you visually when measurements exceed limits
- Includes Type K thermocouple bead probe
- Compatible with all standard mini-connector K-type thermocouples
- Data logging with a date/time stamp
- Soft rubber boot for increased ruggedness
- User interface available in 6 languages

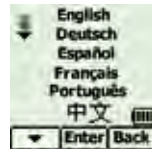

Choose your language

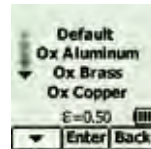

Select the measurement surface



See complete measurement details in seconds



The Fluke 566 and included accessories



The Fluke 568 and included accessories

Specifications

(Check the Fluke web for detailed specifications)

	566	568
Infrared temperature range	-40 °C to 650 °C	-40 °C to 800 °C
Infrared accuracy	$< 0\text{ °C} : \pm (1.0\text{ °C} + 0.1\%/1\text{ °C})$; $> 0\text{ °C} : \pm 1\% \text{ or } \pm 1.0\text{ °C, whichever is greater}$	
Display resolution	0.1 °C	
Infrared spectral response	8 μm to 14 μm	
Infrared response time	< 500 msec	
Input temperature range	-270 °C to 1372 °C	
Input accuracy	$-270\text{ °C to } -40\text{ °C} : \pm (1\text{ °C} + 0.2\%/1\text{ °C})$; $-40\text{ °C to } 1372\text{ °C} : \pm 1\% \text{ or } 1\text{ °C, whichever is greater}$	
D:S (Distance to measurement spot size)	30:1	50:1
Laser sighting	Single-point laser < 1 mw output Class 2 (II) operation, 630 nm to 670 nm	
Minimum spot size	19 mm	
Emissivity adjustment	By built-in table of common materials or digitally adjustable from 0.10 to 1.00 by 0.01	
Data logging with Date/Time stamp	20 points	99 points
PC interface and cable	None	USB 2.0 with FlukeView® Forms software
Hi/Low alarms	Audible and two-color visual	
Min/Max/Avg/Dif	Yes	
Display	Dot matrix 98 x 96 pixels with function menus	
Backlight	Two levels, normal and extra bright for darker environments	
Trigger Lock	Yes	
Switchable between Celsius and Fahrenheit	Yes	

Power: 2 AA/LR6 Batteries (566); 2 AA/LR6 Batteries and USB for use with a PC (568)
Battery life: Used continuously; laser and backlight on: 12 hours; laser and backlight off: 100 hours

Weight: 0.965 kg (566); 1.026 kg (568)
Size (HxLxW): 25.4 cm x 19.1 cm x 6.9 cm
Operating temperature: 0 °C to 50 °C
Storage temperature: -20 °C to 60 °C
Two years warranty

Included accessories

FlukeView® Forms software (568 only), USB cable (568 only), K-type thermocouple bead probe, 2 AA batteries, hard carrying case, quick start guide, and users manual.

Ordering information

Fluke 566 Infrared thermometer
 Fluke 568 Infrared thermometer

Recommended Accessories



H6
See page 131

80PK-8
See page 128

80PK-9
See page 128

80PK-11
See page 128

80PK-25
See page 128

80PK-26
See page 128

561 Multipurpose Thermometer

FLUKE®



Fluke 561

Combined Infrared and Contact Thermometer

The Fluke 561 combines the temperature measurement functions that industrial, electrical, and HVAC/R professionals need, all in one tool. It measures both IR and contact temperature, replacing several other test tools. It's fast, efficient, and easy to use, saving you valuable time and effort. With the Fluke 561, you can take contact and ambient temperatures in the way that's best for you. Use the IR thermometer to measure hot, moving, electrically energized, and hard-to-reach objects instantly. Check motors, insulation, breakers, radiant heating, pipes, corroded connections, and wires. Plus, scan ducts, and other hard-to-reach objects from the floor—leave your ladder in the truck. You can use the Fluke 561's handy Velcro® pipe probe or, plug in any industry standard, K-type mini-connector thermocouple probe you already own.

- IR thermometer for quick measurements up close or at a distance
- Single-point laser sighting
- Easy emissivity adjustment for measuring pipes and ducts more accurately
- Includes a Velcro pipe probe for super-heat and sub-cooling as well as other surface contact measurements
- Also compatible with all standard mini-connector K-type thermocouples
- MIN, MAX and DIF temperature readings
- Lightweight (only 340 grams) and portable
- Includes measurement guide



The Fluke 561 includes everything you need for immediate inspections.

Specifications

Temperature range	-40° to 550°C
Display resolution	0.1° of reading
D:S (Distance to spot size)	12:1
Easy emissivity selector	Adjustable with three settings: low (0.3), medium (0.7), high (0.95)
Display accuracy (Assumes ambient operating temperature of 23° to 25°C)	± 1.0% of reading or ± 1°C, whichever is greater; below 0°C, ± 1°C, ± 1°/1°
Response time	500 mSec (95% or reading)
Repeatability	± 0.5% of reading or ± 1°C, whichever is greater
Spectral focus	8 µm to 14 µm
Laser sighting	Single-point laser
Laser shutoff	Laser turns off above ambient temperature of 40°C
Laser power	Class 2 (II) operation; output < 1 mW, wavelength 630 nm to 670 nm
Relative humidity	10% to 90% RH non-condensing, at < 30°C
Power	2 AA batteries (alkaline or NiCD)
Display hold	7 seconds
Backlit display	Yes, LCD with dual temperatures (current and MAX/MIN/DIF/KTC), low battery, F/C indicator, and Scan/Hold options
Operating temperature	0° to 50°C
Storage temperature	-20 to 65°C
MAX, MIN, DIF temperatures	Yes
Thermocouple type K mini-adapter input	Yes, compatible with industry standard type K probes with mini-connector
Thermocouple type K Velcro pipe probe	Yes, with a temperature range of 0° to 100°C and accuracy of ± 2.2°C
Measurement guide	Yes

Battery Life (alkaline): 12 hours

Weight: 340 grams

Size (HxLxW): 176,9 mm x 163,6 mm x 51,8 mm **Two years warranty**

Included accessories

Thermocouple K-type Velcro pipe probe, hand carrying case, 2 AA batteries and user manual with measurement guide.

Ordering information

Fluke 561 HVACPro Thermometer

Recommended Accessories



H6
See page 131



80-PK-1
See page 128



80PK-8
See page 128



80PK-25
See page 128

50 Series II Thermometers



Fluke 54 II B



Fluke 51 II



Fluke 52 II



Fluke 53 II B



Included Accessories

Impact absorbing holster
Two bead probe thermocouples 80PK-1 (54+52)
One bead probe thermocouple 80PK-1 (51+53)

Ordering Information

Fluke 51 II Thermometer
Fluke 52 II Thermometer
Fluke 53 II B Thermometer
Fluke 54 II B Thermometer
FVF-SC2 FlukeView Forms Software including USB interface cable

Laboratory accuracy. Wherever you go.

The Fluke 50 Series II contact thermometers offer fast response and laboratory accuracy (0.05% + 0.3°C) in a rugged handheld test tool.

- Large backlit dual display shows any combination of T₁, T₂ (52 and 54 only), T₁-T₂ (52 and 54 only) plus MIN, MAX, or AVG
- Relative time clock on MIN, MAX, and AVG provides a time reference for major events
- Electronic Offset function allows compensation of thermocouple errors to maximize overall accuracy
- Readout in °C, °F, or Kelvin (K)
- Sleep mode increases battery life
- Battery door allows easy battery replacement without breaking the calibration seal

Additional features for the 53 and 54 Series II:

- Data Logging up to 500 points of data with user adjustable recording interval
- Real time clock captures the exact time of day when events occur
- Recall function allows logged data to be easily reviewed on the meter display
- IR communication port allows data to be exported to optional FlukeView® PC software

Features

	51 II	52 II	53 II B	54 II B
Thermocouple types	J,K,T,E	J,K,T,E	J,K,T,E,N,R,S	J,K,T,E,N,R,S
Number of inputs	Single	Dual	Single	Dual
Time stamp	Relative Time	Relative Time	Time of Day	Time of Day
Splash/Dust resistant	●	●	●	●
Dual display with backlight	●	●	●	●
Min/Max/Avg recording	●	●	●	●
(T ₁ -T ₂) True differential		●		●
Data logging up to 500 points			●	●
IR data port for interface to PC			●	●
Compatible with optional FlukeView Software			●	●

Specifications

Temperature range:	
J-type Thermocouples	-210°C to 1200°C
K-type Thermocouples	-200°C to 1372°C
T-type Thermocouples	-250°C to 400°C
E-type Thermocouples	-150°C to 1000°C
N-type** Thermocouples	-200°C to 1300°C
R** and S-type** Thermocouples	0°C to 1767°C
Temperature accuracy	
Above -100°C (-148°F):	
J, K, T, E, and N-type**	± [0.05% + 0.3°C]
R** and S-type**	± [0.05% + 0.4°C]
Below -100°C (-148°F):	
J, K, E, and N-types	± [0.20% + 0.3°C]
T-type	± [0.50% + 0.3°C]

**Only the Fluke Models 53 and 54 Series II thermometers are capable of measuring N, R, and S-type

Battery life: 1000 hours typical, AA
Size (HxWxD): 173 x 86 x 38 mm

Weight: 0.4 kg
Three Year Warranty

Recommended Accessories



C25
See page 130



80PK-26
See page 128



80PK-25
See page 128



FVF-SC 2
See page 132



TPAK
See page 132

1523 and 1524 Reference Thermometers

FLUKE®



Fluke 1524

Fluke 1523

Note: The 1523/24 are pictured with probes connected which may be purchased separately.

Included Accessories

NIST traceable certificate of calibration, users guide, CD-ROM (contains technical manual), 12 V dc universal power supply, RS-232 cable, 9940 I/O ToolKit software

Ordering Information

Fluke 1523* Reference Thermometer
 Fluke 1524* Reference Thermometer
 Fluke 1523-P1 Reference Thermometer, PRT(-200 °C to 420 °C, 6.35 mm x 298 mm), Universal Thermocouple Adapter, TPAK, and Case
 Fluke 1524-P1 Reference Thermometer, PRT(-200 °C to 420 °C, 6.35 mm x 298 mm), Universal Thermocouple Adapter, TPAK, and Case

* Requires an optional probe

Optional Accessories

2384-P INFO-CON Connector, PRT (Gray Cap), Spare
 2384-T INFO-CON Connector, Thermocouple (Blue Cap), Spare
 2373-LPRT RTD Adapter, Lemo to Mini Grabbers (4-wire)

Optional probes:

5616-12-P PRT, 6.35 mm x 298 mm, -200 °C to 420 °C
 5615-9-P PRT, 4.76 mm x 229 mm, -200 °C to 420 °C
 5610-9-P Thermistor, 3.2 mm x 229 mm, 0 °C to 100 °C

A new standard in accuracy and versatility.

Measure, graph and record three sensor types with one tool. The Fluke 1523/24 Reference Thermometer deliver high accuracy, wide measurement range, logging, and trending, all in a handheld tool you can take anywhere. For top accuracy, a memory chip inside the probe connector feeds probe calibration information to the readout. In addition, any thermocouple with a mini-thermocouple connector can be read using the optional universal thermocouple adapter. Choose the 1523 for single channel or the 1524 for dual channel measurement.

Three sensor types

- PRTs: -200 °C to 1000 °C
- Thermocouples -200 °C to 2315 °C
- Precision thermistors: -50 °C to 150 °C

High accuracy

- PRTs: ±0.011 °C
- Thermocouples: ±0.24 °C for J,K,L,M
- Precision thermistors: ±0.002 °C

Fast measurement

- PRTs: up to 0.45 seconds/sample
- Thermocouples: up to 0.3 seconds/sample
- Precision thermistors: up to 0.3 seconds/sample

Two models

- 1523: Single channel standard model; memory for 25 readings & statistics
- 1524: Two channels; memory for 25 readings and statistics plus logging 15,000 measurements; real-time clock for time and date stamps

Features

	1523	1524
Sensor Types	PRT & RTD, Thermistor, and Thermocouple	
Thermocouple Types	B,C,E,J,K,L,M,N,R,S,T,U	
Number of inputs	Single	Dual
Data trending (graphing)	●	●
Graphical display with backlight	●	●
Min/Max/Avg/Standard deviation recording	●	●
High speed measurement	●	●
RS-232 PC communications	●	●
T1-T2 True differential	●	●
Data logging up to 15,000 points		●
Time and date stamp		●

Specifications

(Check the Fluke web for detailed specifications)

Temperature range	
Thermocouple	-200 °C to 2315 °C
PRT & RTD	-200 °C to 1000 °C
Thermistor	-50 °C to 150 °C
Resolution and best accuracy	
Thermocouple	0.01 °, ±0.24 °C
PRT & RTD	0.001 °, ±0.011 °C
Thermistor	0.001 °, ±0.002 °C
Operating temperature	-10 °C to 60 °C
Storage temperature	-20 °C to 70 °C

Battery life (alkaline): 20 hours
Power supply: Universal 12 Vdc
Size (HxWxD): 200 x 96 x 47 mm
Weight: 0.65 kg
Warranty: 1 year

Recommended Accessories



1551A Ex / 1552A Ex Intrinsically Safe “Stik” Thermometers

New



1552A Ex



1551A Ex



The new “gold standard” of industrial temperature calibration

Finally, a digital substitute for your mercury-in-glass thermometers! Highly accurate and durable, the Fluke 1551A Ex/1552A Ex “Stik” Thermometer is soon to become the new “gold standard” of industrial temperature calibration. Whether working outdoors in environments where potentially explosive gases may be present or on the floor of a processing plant, the intrinsically safe, battery-operated, portable reference thermometer is designed to go where you work.

The RTD sensor of the “Stik” Thermometer is housed in a rugged stainless steel sheath—you no longer have to worry about breaking a mercury-in-glass thermometer and the subsequent cleanup. The probe and digital readout are fixed together, calibrated as a system, and accurate to ± 0.05 °C over the full

temperature range. The large backlit LCD display rotates 90° making it easy to read from any position. Minimize measurement errors with the user-configurable temperature trend/stability indicator which tells you when your temperature source is stable or if your temperature is trending up or down.

- ± 0.05 °C accuracy over full range
- Intrinsically safe (ATEX compliant)
- Display temperature in °C or °F
- Optional data logging to internal memory
- Temperature trend indicator
- User selectable resolution (0.1, 0.01, 0.001)
- 300 hour battery life
- Percent battery-life and low battery indicator
- NVLAP accredited calibration (NIST traceable)



Specifications

	1551A Ex	1552A Ex
Temperature range	-50 °C to 160 °C	-80 °C to 300 °C
Accuracy (1 year)	± 0.05 °C	
Display units	°C, °F	
Sensor type	100 Ω thin film RTD	100 Ω wire-wound PRT
Probe temperature coefficient	0.00385 $\Omega/\Omega/^\circ\text{C}$ nominal	
Sensor length	≤ 10 mm	≤ 30 mm
Sensor position (from sheath tip)	3 mm	
Minimum immersion depth ¹	70 mm	120 mm
Probe sheath material	SST	
Response time	4.8 mm diameter probe (3/16 in): 14 seconds 6.35 mm diameter probe (1/4 in): 21 seconds	
Probe hysteresis	± 0.01 °C	
Temperature resolution	Selectable: 0.1, 0.01, 0.001 (default 0.01)	
Sample rate	Selectable: 0.5, 1, 2, seconds (default 1)	
Operating temperature range of readout	-10 to 50 °C	
Storage temperature	-20 °C to 60 °C, 0 to 95% RH, non-condensing	
Optional data logging ²	Up to 10k time-stamped readings stored to internal memory	
Logging intervals ²	2, 5, 10, 30, or 60 seconds; 2, 5, 10, 30, or 60 minutes	
Averaging	Moving average of most recent 2 to 10 readings, user selectable (ON/OFF, 2, 5, 10)	
Communications	RS-232 stereo jack (access calibration parameters only)	
EMC compliance	EN61326:2006 Annex C; CISPR II, Edition 5.0-2009; Class “B”	
Enclosure rating	IP50	
Calibration	NVLAP accredited, NIST Traceable System Calibration	
Characterization	CVD	ITS-90

¹ Per ASTM E 644

² See ordering information for optional data logging configurations

Included Accessories

NVLAP -accredited report of calibration, user's guide on CD-ROM, 3 AAA batteries

Ordering Information

- 1551A-9 “Stik” Thermometer
- 1551A-12 “Stik” Thermometer
- 1551A-20 “Stik” Thermometer
- 1551A-9-DL “Stik” Thermometer with datalogging
- 1551A-12-DL “Stik” Thermometer with datalogging
- 1551A-20-DL “Stik” Thermometer with datalogging
- 1552A-12 “Stik” Thermometer
- 1552A-12-DL “Stik” Thermometer with datalogging

Note: Model number appended with a -9, -12, -20 indicates probe sheath length in inches. All probe diameters are 6.35 mm with the exception of the 1551A-9, which is 4.8 mm diameter

Battery Life: 300 hours typical without LCD, 3 AAA
Size (HxWxD): 114 x 57 x 25 mm
Weight: 196 grams
Warranty: 1 year

Recommended Accessories



1551-CASE
Carrying case

1551-CBL
RS-232 cable

Thermal Imagers

Temperature changes can indicate problems in many everyday applications and a thermal imager makes it quick and easy to visually check surface temperatures. Often problems can be discovered before contact measurements even need to be made. Fluke offers a complete range of handheld thermal imagers for both industrial and building diagnostic applications. Models are available for any budget.

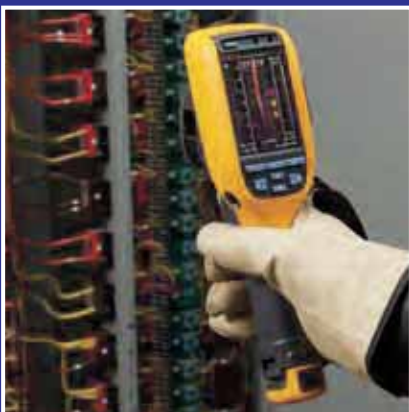

Ti Series Thermal Imagers

Find it, fix it, fast!

Temperature changes can indicate problems in many areas you see everyday, some include:

- **Inside electrical distribution and service** (Switch gear, panels, controls, fuses, transformers, receptacles, lighting, conductors, bus bars, motor control centers)
- **Motors, pumps and mechanical** (Electric motors and generators, pumps, compressors, evaporators, bearings, couplings, gearboxes, gaskets/seals, belts, rollers, disconnects)
- **Process** (Tanks and vessels, pipes, valves and traps, reactors, process insulation)
- **HVAC/R** (air conditioning, heating, air handlers, refrigeration)
- **Outside electrical distribution - utilities** (Transformers, bushings, insulators, transmission lines, other exterior conductors, service connections, disconnects, capacitor banks)



Overheating bearing cap

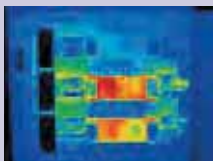

Three-phase switch-gear load imbalance

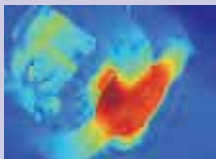

Overheated motor

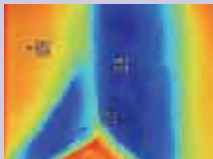

Cool corner in a building

IR-Fusion® Technology: Infrared and visual images fused together in one image

See things both ways - Infrared and visual (visible light) images fused together communicating critical information faster and easier - traditional infrared images are no longer enough. Patented IR-Fusion® Technology, only available from Fluke, simultaneously captures a digital photo and the infrared image and fuses them together taking the mystery out of IR image analysis.

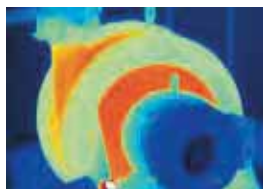

Full IR

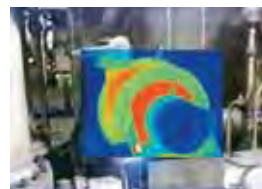

Picture-in-Picture

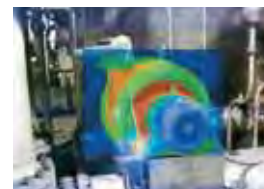

Alpha Blending



IR/Visible Alarm



Full Visible Light



SmartView® Software

Fluke SmartView® software is included with each Fluke Thermal Imager. This powerful software is a modular suite of tools that annotates, views, edits and analyzes IR images.

It also generates fully customizable and professional-looking reports in a few easy steps. The IR-Fusion technology is fully supported.



FREE webinars/webcasts on Thermal Imaging

Keep up-to-date on the latest troubleshooting techniques. Attend a FREE Fluke webinar (web-based seminar) about thermal imaging applications. Go to the Fluke website for more information.

Ti32/Ti29/Ti27 Industrial/ Commercial Thermal Imagers

FLUKE®



Fluke Ti32

New



Fluke Ti29

New



Fluke Ti27

The New P3 Series from Fluke

Designed for industrial and commercial environments, the Fluke P3 Series of thermal imagers deliver superior image quality, versatility, and affordability without compromise. They also boast superior infrared resolution, industry leading spatial resolution, and a high definition display creating the sharpest images in their price classes. Finding a potential problem before it becomes a costly disaster shows you just how much a Fluke thermal imager can save you in time, money and even lives.

Superior image quality

- Delivers the clear, crisp images needed to find problems fast with up to 320 x 240 sensor.
- Identify even the smallest temperature differences that could indicate problems with industry-leading thermal sensitivity (NETD), down to 45 mK.
- Automatic alignment (parallax correction) of visual and infrared images with Fluke patented IR-Fusion®.
- Optional telephoto and wide angle lenses available for added versatility and special applications (easily installable in the field).

Easy to use

- Field replaceable batteries give you maximum flexibility no matter where your work takes you.
- Intuitive, three-button menu is easy to use—simply navigate with the push of a thumb.
- No need to carry pen and paper—record findings by speaking into the imager. Voice annotations can be recorded with every image you take. Voice comments are saved along with individual images for future reference.
- One-handed focus capability, emissivity correction, reflected background temperature compensation, and transmission correction increase the accuracy of measurements in most situations.
- Adjustable hand strap for left-or right-handed use.
- Everything needed to get started is included.

Rugged

- Optimized for field use in challenging work environments.
- Engineered and tested to withstand a 2 m drop for the ultimate peace of mind.
- Withstands dust and water—tested to an IP54 rating.
- With their rugged design, integrated lens cover, protected display and 2 meter drop test, they are designed to handle the harshest environments.

Ti32/Ti29/Ti27 Industrial/ Commercial Thermal Imagers

FLUKE®

Specifications



Complete package

	Fluke Ti27	Fluke Ti29	Fluke Ti32
Thermal imaging performance			
Detector type	240 x 180 Focal Plane Array, uncooled microbolometer	280 x 210 Focal Plane Array, uncooled microbolometer	320 x 240 Focal Plane Array, uncooled microbolometer
Field of view (FOV)	23° horizontal x 17° vertical		
Spatial resolution (IFOV)	1.67 mRad	1.49 mRad	1.25 mRad
Min focus distance	15 cm		
Thermal sensitivity (NETD)	≤0.05 °C at 30 °C (50 mK)		≤0.045 °C at 30 °C (45 mK)
Minimum span (auto/manual)	2.5 °C / 5 °C		
Focus	Manual		
Optional telephot infrared lens type			
Field of view (FOV)	11.5" x 8.7"		
Minimum focus distance	45 cm		
Optional wide-angle infrared lens type			
Field of view (FOV)	46" x 34"		
Minimum focus distance	7.5 cm		
Visual imaging performance			
Minimum focus distance	46 cm		
On camera operating modes	Picture-in-Picture and full screen IR plus Blending		
Color Alarm	High temperature alarm		
Visible light camera	2.0 MegaPixel		
Temperature measurement			
Temperature range	-20 °C to 600 °C		
Accuracy	±2 °C or 2%		
Measurement modes	Center point and hot and cold markers		
Image presentation			
Digital display	9.1 cm (3.7") landscape color VGA (640x480) LCD		
LCD backlight	Selectable bright or auto		
Palettes	Ironbow, Blue-Red, High Contrast, Amber, Amber Inverted, Hot Metal, Grayscale, Grayscale Inverted		
Ultra Contrast Palettes	•		
Voice Annotation			
Voice annotation	•		
Image and data storage			
Storage medium	2GB SD Card (3000 .bmp IR images/1200 .IS2 images)		
File formats supported	JPG, JPEG, JPE, JFIF, BMP, GIF, DIB, PNG, TIF, and TIFF		
Controls and adjustments			
Set-up controls	Date/time, C°/F, language On screen emissivity correction On-screen reflected background temperature compensation On-screen transmission correction		
Language selection	Eng, ger, fre, spa, por, ita, swe, fin, rus, cze, pol, tur		
Image controls	Smooth auto scaling and manual scaling		
Power			
Battery type	Two replaceable rechargeable battery packs (Lithium ion)		
Battery operating time	4+ hours per battery pack		

Water and dust resistant: IP54
Size (HxWxD): 277 x 122 x 170 mm
Weight: 1.05 kg
Two Years Warranty



FLK-LENS/TELE1
Telephoto Infrared Lens



FLK/LENS/WIDE
Wide-angle Infrared Lens

Included Accessories

SmartView® software
 2 GB SD card
 SD card reader
 Rugged hard carrying case
 Soft carrying case
 Hand strap
 Rechargeable battery (extra)
 AC charger/power supply
 User manual

Ordering Information

Fluke Ti27 Thermal Imager
 Fluke Ti29 Thermal Imager
 Fluke Ti32 Thermal Imager

Recommended Accessories



Ti-Car Charger
Car charger



FLK-TI-SPB3
Extra battery



FLK-TI-SBC3
Charging base

TiR32/TiR29/TiR27 Building Diagnostic Thermal Imagers

FLUKE®



The New P3 Series from Fluke

Designed specifically for the building inspection professional, the Fluke P3 Series of thermal imagers deliver the perfect balance between performance and price. They also boast superior infrared resolution, spatial resolution, and high definition displays. The P3 Series delivers crisp images and impressive reports with the included professional SmartView® software. Whether you're searching for energy waste, leaky roofs or moisture problems, Fluke P3 thermal imagers offer tested and proven technology that takes the guesswork out of finding problems and provides solutions.

New



Superior image quality

- Delivers the clear, crisp images needed to find problems fast
- Identify even the smallest temperature differences that could indicate problems with industry-leading thermal sensitivity (NETD), down to 40 mK.
- Automatic alignment (parallax correction) of visual and infrared images with Fluke patented IR-Fusion®
- Optional telephoto and wide angle lenses available for added versatility and special applications (easily installable in the field).

New



Easy to use

- Field replaceable batteries give you maximum flexibility no matter where your work takes you.
- Intuitive, three-button menu is easy to use—simply navigate with the push of a thumb.
- No need to carry pen and paper—record findings by speaking into the imager. Voice annotations can be recorded with every image you take. Voice comments are saved along with individual images for future reference.
- One-handed focus capability, emissivity correction, reflected background temperature compensation, and transmission correction increase the accuracy of measurements in most situations.
- Adjustable hand strap for left-or right-handed use.
- Everything needed to get started is included.

Rugged

- Optimized for field use in challenging work environments.
- Engineered and tested to withstand a 2 m drop for the ultimate peace of mind.
- Withstands dust and water—tested to an IP54 rating.
- With their rugged body, integrated lens cover, protected display and 2 meter drop test, they are designed to handle the harshest environments.

TiR32/TiR29/TiR27 Building Diagnostic Thermal Imagers

FLUKE®

Specifications



Complete package

	Fluke TiR27	Fluke TiR29	Fluke TiR32
Thermal imaging performance			
Detector type	240 x 180 Focal Plane Array, uncooled microbolometer	280 x 210 Focal Plane Array, uncooled microbolometer	320 x 240 Focal Plane Array, uncooled microbolometer
Field of view (FOV)	23° horizontal x 17° vertical		
Spatial resolution (IFOV)	1.67 mRad	1.49 mRad	1.25 mRad
Min focus distance	15 cm		
Thermal sensitivity (NETD)	≤0.045 °C at 30 °C (50 mK)		≤0.040 °C at 30 °C (40 mK)
Minimum span (auto/manual)	2.5 °C / 5 °C		
Focus	Manual		
Optional telephot infrared lens type			
Field of view (FOV)	11.5" x 8.7"		
Minimum focus distance	45 cm		
Optional wide-angle infrared lens type			
Field of view (FOV)	46" x 34"		
Minimum focus distance	7.5 cm		
Visual imaging performance			
Minimum focus distance	46 cm		
On camera operating modes	Picture-in-Picture and full screen IR plus Blending		
Color Alarm	Dewpoint alarm		
Visible light camera	2.0 MegaPixel		
Temperature measurement			
Temperature range	-20 °C to 150 °C		
Accuracy	±2 °C or 2%		
Measurement modes	Center point and hot and cold markers		
Image presentation			
Digital display	9.1 cm (3.7") landscape color VGA (640x480) LCD		
LCD backlight	Selectable bright or auto		
Palettes	Ironbow, Blue-Red, High Contrast, Amber, Amber Inverted, Hot Metal, Grayscale, Grayscale Inverted		
Ultra Contrast Palettes	•		
Voice Annotation			
Voice annotation	•		
Image and data storage			
Storage medium	2GB SD Card (3000 .bmp IR images/1200 .IS2 images)		
File formats supported	JPG, JPEG, JPE, JFIF, BMP, GIF, DIB, PNG, TIF, and TIFF		
Controls and adjustments			
Set-up controls	Date/time, C°/F, language On screen emissivity correction On-screen reflected background temperature compensation On-screen transmission correction		
Language selection	Eng, ger, fre, spa, por, ita, swe, fin, rus, cze, pol, tur		
Image controls	Smooth auto scaling and manual scaling		
Power			
Battery type	Two replaceable rechargeable battery packs (Lithium ion)		
Battery operating time	4+ hours per battery pack		

Water and dust resistant: IP54

Size (HxWxD): 277 x 122 x 170 mm

Weight: 1.05 kg

Two Years Warranty



FLK-LENS/TELE1
Telephoto Infrared Lens



FLK/LENS/WIDE
Wide-angle Infrared Lens

Included Accessories

- SmartView® software
- 2 GB SD card
- SD card reader
- Rugged hard carrying case
- Soft carrying case
- Hand strap
- Rechargeable battery (extra)
- AC charger/power supply
- User manual

Ordering Information

- Fluke TiR27 Thermal Imager for Building Diagnostics
- Fluke TiR29 Thermal Imager for Building Diagnostics
- Fluke TiR32 Thermal Imager for Building Diagnostics

Recommended Accessories



Ti-Car Charger
Car charger



FLK-TI-SPB3
Extra battery



FLK-TI-SBC3
Charging base

Ti125/Ti110/Ti100 Industrial / Commercial Thermal Imagers

FLUKE®

New



Ti125



Ti110



Ti100

Industrial and commercial maintenance made easy

Technology isn't working for you if it's slowing you down. Fluke proudly introduces five new thermal imagers specifically designed to help you do more in less time, while being at home in the harshest of environments. A project that might normally take an hour can now be done in minutes. Our newest imagers are the lightest, most rugged, easiest-to-use professional imagers you can buy.

IR-OptiFlex™ focus system

Discover issues significantly faster with Fluke's revolutionary, ultra-rugged focus system. The IR-OptiFlex focus system gives you optimum focus by combining focus-free ease-of-use with the flexibility of manual focus on the same camera!

IR-Fusion® technology

Enjoy the industry's best point-and-shoot IR-Fusion camera. Fluke patented technology blends digital and infrared images into a single image to precisely document problem areas.

Rugged one-hand operation

Experience the most rugged and reliable, lightweight professional camera around. One-touch focus, laser pointer, and torch. Point-and-shoot simplicity. No one builds more rugged, ergonomic tools than Fluke.

Multi-mode video recording

Troubleshoot with the industry's only thermal imager that records focus-free video in visible light and infrared with full IR-Fusion capabilities. Monitor processes over time, easily create infrared video reports, and troubleshoot.

IR-PhotoNotes™ annotation system

Get an exact reference to your problem area by capturing up to three digital photos per file. Add images of equipment, motor nameplates, workroom doors or any other useful or critical information.

Electronic compass

Make sure you and others know the location of the problem. Compass readings easily appear in images and reports.

Ti125/Ti110/Ti100 Industrial / Commercial Thermal Imagers

FLUKE®

Specifications



	Fluke Ti125	Fluke Ti110	Fluke Ti100
	Industrial-Commercial		General
Thermal imaging performance			
IR resolution (FPA size)	160 x 120 FPA Uncooled Microbolometer		
Field of view (FOV)	22.5 °H x 31 °V		
Spatial resolution (IFOV)	3.39 mRad		
Thermal sensitivity (NETD)	≤ 0.10 °C at 30 °C target temp (100 mK)		
Minimum span in auto mode	5 °C		
Minimum span in manual mode	2.5 °C		
Minimum IR focus distance	15.25 cm (6 in)		1.2 m (4 ft)
Focus mechanism	IR-OptiFlex™ focus system		Focus-free 1.2 m and beyond
IR-Fusion® technology	PIP, FULL IR, FULL VISIBLE, AutoBlend	PIP, FULL IR, FULL VISIBLE	No, full IR only
Color alarms	High temperature, low temperature, isotherm	High temperature	-
Visual imaging performance			
Visible camera	2 megapixel industrial-grade		n/a
LCD display	3.5 inch diagonal (portrait format)		
Hot/Cold markers	Yes	-	-
User definable spot markers	Three on camera and in SmartView®		in SmartView® only
Centerbox (MIN/AVG/MAX)	Yes	-	-
Level and span control	Manual and auto		
IR-PhotoNotes™ annotation system	Yes (3 images)		-
Laser pointer	-	Yes	-
Torch	Yes	-	-
Electronic (cardinal) compass	Yes	-	-
Emissivity correction	-	Yes	-
Transmission correction	Yes	-	-
Video			
Multi-mode video output	Streaming USB video output	-	-
Multi-mode video recording (standard AVI with MPEG encoding)	Yes (AVI with MPEG encoding)		-
Multi-mode video recording (radiometric .IS3)	Yes, radiometric .is3 for approx. 2.5 to 5 minutes depending upon thermal scene	-	-
Temperature measurement			
Temperature measurement range (not calibrated below -10° C)	-20 °C to +350 °C		-20 °C to +250 °C
Accuracy	± 2 °C or 2 % (at 25 °C nominal, whichever is greater)		
Image presentation			
Standard palettes	Blue-Red, Grayscale, Inverted Grayscale, High-contrast, Hot Metal, Ironbow, Amber, Inverted Amber		Blue-Red, Ironbow, Grayscale, Amber
Ultra Contrast™ palettes	Blue-Red, Grayscale, Inverted Grayscale, High-contrast, Hot Metal, Ironbow, Amber, Inverted Amber	Blue-Red, Grayscale, Ironbow	-
Voice Annotation			
Voice annotation	Yes (60 seconds) per image		-
Image and data storage			
Memory storage	2 GB SD memory card		
Power			
Battery (field-replaceable, rechargeable)	Two	One	
Battery life	4+ hours (each) (assumes 50% brightness of LCD)		

Included Accessories

SmartView® software
 AC power adapter
 Lithium ion smart battery
 USB cable
 2 GB SD memory card
 Hard carrying case
 Soft transport bag
 Adjustable hand strap
 User manual
 Two-bag charging base and multi-format USB memory card reader (Ti125 only)

Ordering Information

Fluke Ti125 Industrial-Commercial Thermal Imager
 Fluke Ti110 Industrial-Commercial Thermal Imager
 Fluke Ti100 General Use Thermal Imager

Water and dust resistant: IP54
Size (HxWxD): 284 x 86 x 135 mm
Weight: 0.726 kg
Two Years Warranty

Recommended Accessories



Ti-Car Charger
Car charger



FLK-TI-SPB3
Extra battery



FLK-TI-SBC3
Charging base

TiR125/TiR110/Ti100 Building Diagnostic Thermal Imagers

FLUKE®

New



TiR125



TiR110



Ti100



Building diagnostics made easy

Technology isn't working for you if it's slowing you down. Fluke proudly introduces five new thermal imagers specifically designed to help you do more in less time, while being at home in the harshest of environments. A project that might normally take an hour can now be done in minutes. Our newest imagers are the lightest, most rugged, easiest-to-use professional imagers you can buy.

IR-OptiFlex™ focus system

Discover issues significantly faster with Fluke's revolutionary, ultra-rugged focus system. The IR-OptiFlex focus system gives you optimum focus by combining focus-free ease-of-use with the flexibility of manual focus on the same camera!

IR-Fusion® technology

Enjoy the industry's best point-and-shoot IR-Fusion camera. Fluke patented technology blends digital and infrared images into a single image to precisely document problem areas.

Rugged one-hand operation

Experience the most rugged and reliable, lightweight professional camera around. One-touch focus, laser pointer, and torch. Point-and-shoot simplicity. No one builds more rugged, ergonomic tools than Fluke.

Multi-mode video recording

Troubleshoot with the industry's only thermal imager that records focus-free video in visible light and infrared with full IR-Fusion capabilities. Monitor processes over time, easily create infrared video reports, and troubleshoot.

IR-PhotoNotes™ annotation system

Always have references handy – IR-PhotoNotes™ annotation system – quickly identify and keep track of inspection locations by adding digital images of important information and surrounding areas (TiR110 and TiR125).

Electronic compass

Make sure you and others know the location of the problem. Compass readings easily appear in images and reports.

TiR125/TiR110/Ti100 Building Diagnostic Thermal Imagers

FLUKE®



Specifications

	Fluke TiR125	Fluke TiR110	Fluke Ti100
	Building diagnostics		General
Thermal imaging performance			
IR resolution (FPA size)	160 x 120 FPA Uncooled Microbolometer		
Field of view (FOV)	22.5 °H x 31 °V		
Spatial resolution (IFOV)	3.39 mRad		
Thermal sensitivity (NETD)	≤ 0.08 °C at 30 °C target temp (80 mK)		≤ 0.10 °C at 30 °C target temp (100 mK)
Minimum span in auto mode	2.5 °C		5 °C
Minimum span in manual mode	2.0 °C		2.5 °C
Minimum IR focus distance	15.25 cm (6 in)		1.2 m (4 ft)
Focus mechanism	IR-OptiFlex™ focus system		Focus-free 1.2 m and beyond
IR-Fusion® technology	PIP, FULL IR, FULL VISIBLE, AutoBlend	PIP, FULL IR, FULL VISIBLE	No, full IR only
Color alarms	High temperature, low temperature (dewpoint), and isotherm	Low temperature (dewpoint)	-
Visual imaging performance			
Visible camera	2 megapixel industrial-grade		n/a
LCD display	3.5 inch diagonal (portrait format)		
Hot/Cold markers	Yes	-	-
User definable spot markers	Three on camera and in SmartView®		in SmartView® only
Centerbox (MIN/AVG/MAX)	Yes	-	-
Level and span control	Manual and auto		
IR-PhotoNotes™ annotation system	Yes (3 images)		-
Laser pointer	-	Yes	-
Torch	Yes	-	-
Electronic (cardinal) compass	Yes	-	-
Emissivity correction	-	Yes	-
Transmission correction	Yes	-	-
Video			
Multi-mode video output	Streaming USB video output	-	-
Multi-mode video recording (standard AVI with MPEG encoding)	Yes (AVI with MPEG encoding)		-
Multi-mode video recording (radiometric .IS3)	Yes, radiometric .is3 for approx. 2.5 to 5 minutes depending upon thermal scene	-	-
Temperature measurement			
Temperature measurement range (not calibrated below -10° C)	-20 °C to +150 °C		-20 °C to +250 °C
Accuracy	± 2 °C or 2 % (at 25 °C nominal, whichever is greater)		
Image presentation			
Standard palettes	Blue-Red, Grayscale, Inverted Grayscale, High-contrast, Hot Metal, Ironbow, Amber, Inverted Amber		Blue-Red, Ironbow, Grayscale, Amber
Ultra Contrast™ palettes	Blue-Red, Grayscale, Inverted Grayscale, High-contrast, Hot Metal, Ironbow, Amber, Inverted Amber	Blue-Red, Grayscale, Ironbow	-
Voice Annotation			
Voice annotation	Yes (60 seconds) per image		-
Image and data storage			
Memory storage	2 GB SD memory card		
Power			
Battery (field-replaceable, rechargeable)	Two	One	
Battery life	4+ hours (each) (assumes 50% brightness of LCD)		

Included Accessories

SmartView® software
 AC power adapter
 Lithium ion smart battery
 USB cable
 2 GB SD memory card
 Hard carrying case
 Soft transport bag
 Adjustable hand strap
 User manual
 Two-bag charging base and multi-format USB memory card reader (Ti125 only)

Ordering Information

Fluke TiR125 Building Diagnostics Thermal Imager
 Fluke TiR110 Building Diagnostics Thermal Imager
 Fluke Ti100 General Use Thermal Imager

Water and dust resistant: IP54
Size (HxWxD): 284 x 86 x 135 mm
Weight: 0.726 kg
Two Years Warranty

Recommended Accessories



Ti-Car Charger
Car charger



FLK-TI-SPB3
Extra battery



FLK-TI-SBC3
Charging base

Ti9/Ti10/Ti25 Thermal Imagers



Fluke Ti25

The rugged and affordable tools for electricians and technicians

Get the full picture instantly with the Fluke Ti9/Ti10/Ti25 thermal imagers. Built for tough work environments, these fully radiometric imagers are ideal for detecting problems in a wide range of equipment including switchgear, motor control centers and lighting systems.

- Delivers the clear images to find problems fast with its 160x120 sensor
- Even the smallest details become visible with the large, widescreen full color LCD display
- Optimized for field use in harsh work environments
 - Engineered and tested to withstand a 2 meter drop
 - Withstands dust and water – tested to an IP54 rating
 - Innovative protective lens cover protects the lens when not in use
- Enhanced problem detection and analysis capabilities with patent pending IR-Fusion® Technology (Ti10 and Ti25)
- Intuitive, three-button menu is easy to use ... simply navigate with the push of a thumb
- Store more than 3.000 screen images (.bmp format) or 1.200 fully radiometric images (.IS2 format) on included 2 GB SD memory card



Fluke Ti10

IR-Fusion® Technology



See things both ways—infrared and visual (visible light) images fused together communicating critical information faster and easier—traditional infrared images are no longer enough. IR-Fusion, a patent-pending technology that simultaneously captures a digital photo in addition to the infrared image and fuses it together taking the mystery out of IR image analysis. IR-Fusion is standard on Ti10 and Ti25 models. The Fluke Ti9 can be upgraded to a full Fluke Ti10 with IR-Fusion at a later time.



Fluke Ti9

Ti9/Ti10/Ti25 Thermal Imagers

Specifications



Complete package

	Fluke Ti9	Fluke Ti10	Fluke Ti25
Thermal imaging performance			
Detector type	160 x 120 Focal Plane Array, uncooled microbolometer		
Field of view (FOV)	23° horizontal x 17° vertical		
Spatial resolution (IFOV)	2.5 mRad		
Min focus distance	15 cm		
Thermal sensitivity (NETD)	≤0.2 °C at 30 °C (200 mK)	≤0.13 °C at 30 °C (130 mK)	≤0.09 °C at 30 °C (90 mK)
Minimum span (auto/manual)	10 °C / 5 °C	10 °C / 5 °C	2.5 °C / 5 °C
Focus	Manual		
Visual imaging performance			
Minimum focus distance		46 cm	46 cm
On camera operating modes		Picture-in-Picture and full screen IR plus	Picture-in-Picture and full screen IR plus Blending
Visible light camera		1.3 MegaPixel	1.3 MegaPixel
Temperature measurement			
Temperature range	-20 °C to 250 °C	-20 °C to 250 °C	-20 °C to 350 °C
Accuracy	± 5 °C or 5%	± 2 °C or 2%	± 2 °C or 2%
Measurement modes	Center point	Center point	Center point and hot and cold markers
Image presentation			
Digital display	9.1 cm (3.6") landscape color VGA (640x480) LCD		
LCD backlight	Selectable bright or auto		
Palettes	Ironbow, blue-red, high contrast, grey		Ironbow, blue-red, high contrast, grey, amber and hot metal
Image and data storage			
Storage medium	2GB SD Card (3000 .bmp IR images/1200 .IS2 images)		
File formats supported	JPG, JPEG, JPE, JFIF, BMP, GIF, DIB, PNG, TIF, and TIFF		
Controls and adjustments			
Set-up controls	Date/time, C°/F, language		Date/time, C°/F, language On screen emissivity correction On-screen reflected background temperature compensation
Language selection	Eng, ger, fre, spa, por, ita, swe, fin, rus, cze, pol, tur		
Image controls	Smooth auto scaling and manual scaling		
Power			
Battery type	Internal rechargeable battery NiMH (included)		
Battery operating time	3 to 4 hours continuous operation		

Water and dust resistant: IP54

Size (HxWxD): Ti9/Ti10/Ti25: 267 x 127 x 152 mm

Weight: Ti9/Ti10/Ti25: 1.2 kg

Two Years Warranty

Included Accessories

- SmartView® software
- 2 GB SD card
- SD card reader
- Rugged hard carrying case
- Soft carrying case
- Hand strap
- Rechargeable battery
- AC charger/power supply
- User manual

Ordering Information

- Fluke Ti9 Electrical Thermal Imager
- Fluke Ti10 Electrical Thermal Imager
- Fluke Ti25 Industrial Thermal Imager

Recommended Accessories



Ti-Visor
Sun Visor
(for complete Ti Series)



Ti-Car Charger
Car charger

TiS/TiR/TiRx/TiR1 Thermal Imagers for Building Diagnostics

FLUKE®



Fluke TiS

Entry-level Thermal Imager

Fluke's entry level thermal imager for quick, easy, and accurate problem identification and troubleshooting designed specifically for the building inspection professional. Whether you are a building inspector, plumber, roofer, electrician, energy auditor, HVAC, insulator, or windows installer the Fluke Thermal Imaging Scanner is the perfect tool to help you identify hidden building construction issues, find moisture intrusion, detect energy loss/missing insulation, and many basic electrical connection and load problems. Now Fluke quality, durability, and performance are available in a thermal imager engineered for the valueconscious building professional. The Fluke TiS Thermal Imaging Scanner is the top-performing imager in its price class.

- Highest resolution (120x120) in price class
- Only imager in price class with versatile, manual focus
- Largest display size (3.7") in price class.
- Long battery life lasts ~4 hours
- Rugged body engineered to withstand 2 m drop test
- Easy to use—the TiS Thermal Imaging Scanner provides you with a basic, reliable solution for the building professional
- NETD 100 mK



Fluke TiR

Optimized for energy audits, restoration and remediation

The affordable rugged Fluke TiRx and TiR Thermal Imagers are workhorse tools for the demands of building envelope, restoration and remediation, inspection and roofing applications. Whether to perform energy audits, locate the origins of construction problem or to find roof leaks, the TiRx and TiR offer an economical solution for complete detection, analysis and documentation.

- Delivers the clear images to find problems fast with its 160x120 sensor
- Enhanced problem detection and analysis capabilities with patent pending IR-Fusion® Technology (TiR)
- The Fluke TiRx can be upgraded to a full Fluke TiR with IR-Fusion at a later time.
- NETD 90 mK



Fluke TiRx

The professional's choice

The TiR1 Thermal Imager is the professional's choice for building diagnostics. The Fluke TiR1 has all the features of the Fluke TiR, but with an NETD of 0.07°C for the TiR1 to identify even small temperature differences that could indicate problems.

- IR-Fusion®, full option (combines visible image with IR image in full screen or picture-in-picture views)
- Voice recording; record findings by speaking into the camera. Voice annotations can be recorded with every image you take. Voice comments are saved along with individual images for future reference
- NETD 70 mK



Fluke TiR1

TiS/TiR/TiRx/TiR1 Thermal Imagers for Building Diagnostics

FLUKE®

Specifications



Complete package

	Fluke TiS	Fluke TiRx	Fluke TiR	Fluke TiR1
Thermal imaging performance				
Detector type	120 x 120 Focal Plane Array, uncooled microbolometer	160 x 120 Focal Plane Array, uncooled microbolometer		
Field of view (FOV)	17° horizontal x 17° vertical	23° horizontal x 17° vertical		
Spatial resolution (IFOV)	2.5 mRad			
Min focus distance	15 cm			
Thermal sensitivity (NETD)	≤0.1 °C at 30 °C (100 mK)	≤0.09 °C at 30 °C (90 mK)	≤0.07 °C at 30 °C (70 mK)	
Minimum span	5 °C (in auto mode)	2.5 °C / 5 °C (Auto/Manual)		
Focus	Manual			
Visual imaging performance				
Minimum focus distance	-	46 cm		
On camera operating modes	-	Picture-in-Picture and full screen IR	Picture-in-Picture and full screen IR plus Blending	
Visible light camera	1.3 MegaPixel			
Temperature measurement				
Temperature range	-20 °C to 100 °C		-20 °C to 150 °C	
Accuracy	± 5 °C or 5%		± 2 °C or 2%	
Measurement modes	Center point			Center point and hot and cold markers
Image presentation				
Digital display	9.1 cm (3.6") landscape color VGA (640x480) LCD			
LCD backlight	Selectable bright or auto			
Palettes	Ironbow, blue-red, greyscale	Ironbow, blue-red, high contrast, grey	Ironbow, blue-red, high contrast, grey, amber and hot metal	
Image and data storage				
Storage medium	2GB SD Card (3000 .bmp IR images/1200 .IS2 images)			
File formats supported	JPG, JPEG, JPE, JFIF, BMP, GIF, DIB, PNG, TIF, and TIFF			
Controls and adjustments				
Set-up controls	Date/time, C°/F, language			Date/time, C°/F, language On screen emissivity correction On-screen reflected background
Language selection	Eng, ger, fre, spa, por, ita, swe, fin, rus, cze, pol, tur			
Image controls	Smooth auto-scaling and lock of level and span	Smooth auto scaling and manual scaling		
Power				
Battery type	Internal rechargeable battery NiMH (included)			
Battery operating time	3 to 4 hours continuous operation			

Water and dust resistant: IP54

Size (HxWxD): 267 x 127 x 152 mm

Weight: 1.2 kg

Two Years Warranty

Included Accessories

SmartView® software
2 GB SD card
SD card reader
Rugged hard carrying case
Soft carrying case
Hand strap
Rechargeable battery
AC charger/power supply
User manual

Ordering Information

Fluke TiS Thermal Imaging Scanner
Fluke TiRx Inspector Thermal Imager
Fluke TiR Thermal Imager for Building Diagnostics
Fluke TiR1 Thermal Imager for Building Diagnostics

Recommended Accessories



Ti-Visor
Sun Visor
(for complete Ti Series)



Ti-Car Charger
Car charger



FLK-TI-SBC3
Charging base (T132)

CRange IRWindows

Increase the safety and speed of electrical thermography



Infrared windows mount into panel doors and covers for switchgear, transformers, bus bars and other live electrical equipment, allowing Infrared, Ultraviolet, Visual and IRfusion technologies to be used without exposing personnel to live equipment.

All infrared windows from Fluke use the unique Quadraband™ multispectral optic, allowing inspection with any camera for total flexibility both now and in the future.

- Reduce the arc flash risk associated with electrical thermography
- Increase efficiency as thermographer can work alone without being accompanied by an electrician to isolate and open panels
- Stay safety compliant with NFPA70E and other safety protocols and leave the panels closed
- Extend the life of your equipment with more frequent IR scans
- Easy to install
- Durable enough to withstand extreme outdoor conditions yet practical for indoor applications as well.



Included Accessories

Installation CD, self-adhesive drilling template, security access key, warranty statement.

Ordering Information

- FLK-075-CLKT 75mm C-Range IR Window, Kwik Twist
- FLK-100-CLKT 100mm C-Range IR Window, Kwik Twist
- IP-200-UK Window Installation Kit 220/240V

Specifications

(Check the Fluke web for detailed specifications)

	FLK-075-CLKT	FLK-100-CLKT
Optic Data		
Crystal Insert Diameter	75 mm	100 mm
Viewing Aperture Diameter	68 mm	89 mm
Viewing Aperture Area	3632 mm ²	6322 mm ²
Thickness	2 mm	4 mm
CLIRVU Coating	●	●
Shortwave IR Capable	●	●
Midwave IR Capable	●	●
Longwave IR Capable	●	●
Ultraviolet (UV) Capable	●	●
Visual Capable	●	●
Fusion Capable	●	●
General		
Maximum Temperature		
Gaskets	250° C	
Body	659 ° C	
Optic	1400° C	
Gaskets	Low Smoke & Fume (LSF) compliant silicone	
IP rating	IP65	
NEMA rating	Type 3/12 (UL & CSA Third Party Certified)	
Vibration rating	IEC60068-2-6	
Humidity rating	IEC60068-2-3	
Pull out strength	Up to 630 kg	

Warranty: Lifetime replacement against manufacturing defects

Laser Distance Meters

The Fluke Laser Distance Meters bring you the most advanced measuring technology. Unlike ultrasonic distance meters with laser pointers, these meters use a precision narrow laser beam that can avoid the common errors caused by extraneous objects near measurement targets.



421D, 416D, 411D Laser Distance Meters

FLUKE®



Fluke 421D



Fluke 411D



Fluke 416D



411D/62 Kit

Combo kit includes:

- Fluke 62 Mini IR Thermometer
- Fluke 411D Laser Distance Meter
- Soft pouch for each model

Included Accessories

Two AAA batteries, Users manual on CD, Quick start guide, Nylon carrying case, Wrist wrap (421D)

Ordering Information

Fluke 411D Laser Distance Meter
Fluke 416D Laser Distance Meter
Fluke 421D Laser Distance Meter

Professional-grade laser distance measuring tools that are fast, easy to use, and fit in your pocket.

The Fluke laser distance meters bring you the most advanced measuring technology. These meters are fast, accurate, durable, and easy to use — just point and shoot. Their straightforward design and easy, one-button operation mean you spend less time measuring. Unlike ultrasonic distance meters with laser pointers, the Fluke 421D, 416D and 411D use a precision narrow laser beam that can avoid the common errors caused by extraneous objects near measurement targets.

These compact and handy Fluke distance meters are designed for indoor, and limited outdoor applications. Addition, subtraction, area, and volume calculations could not be simpler. The extra bright laser is clearly visible so you can see your targeting point even if an object is hard-to-reach or distant. The Fluke 421D, 416D and 411D have a large LCD screen and buttons positioned for one-handed measurements.

Features

	411D	416D	421D
Reduction of estimation errors, saving both time and money	●	●	●
Instant measurement with one-button operation	●	●	●
Easy targeting with bright laser	●	●	●
Quick calculation of area (square footage) and volume	●	●	●
Easy addition and subtraction of measurements	●	●	●
Improved battery life from automatic shut-off feature	●	●	●
Pythagoras calculation for determining distance indirectly from two other measurements	●	●	●
Pouch	●	●	●
Ability to view more with large, 3-line display with backlight	●	●	●
Ability to measure up to	30 m	60 m	100 m
Storage capacity of measurements for quick recall of distance	-	10	20
MIN/MAX function		●	●
Enhanced Pythagoras calculation for determining distance indirectly from three other measurements		●	●
Audible feedback of on and off modes		●	●
Strong environment protection with IP54 (water spray & dust proof) sealing		●	●
Audible feedback for taking room angle and incremental measurements			●
± 45° Tilt sensor for taking indirect measurements in hard to reach areas			●
Tripod mode allows you to mount to a tripod for measuring long distances			●
Built in light sensor for activating the backlight saving battery life			●
Corner angle feature, allows you to determine the angle of a corner			●

Specifications

(Check the Fluke web for detailed specifications)

	Fluke 411D	Fluke 416D	Fluke 421D
Range (for extended distances, use a target plate)	30 m	60 m	100 m
Accuracy	± 3 mm	± 1.5 mm	± 1.5 mm
Measurement units	00.000 m	00.000 m	00.000 m
Measurement storage		10 locations	20 locations
Backlight		●	●
Automatic power off	After 180 seconds	After 180 seconds	After 360 seconds

Operating temperature: 0°C to 40°C

Storage temperature: -25°C to 70°C

Operating altitude: up to 3500 m

Battery Life: 411D: up to 3000 readings
416D, 421D: up to 5000 readings

Size (HxWxD):

411D: 123 mm x 50 mm x 26 mm

416D: 135 mm x 46 mm x 31 mm

421D: 127 mm x 52 mm x 25 mm

Weight:

411D: 0.150 kg

416D: 0.110 kg

421D: 0.125 kg

Warranty: 2 years

Indoor Air Quality Tools

In response to the growing importance of air quality in buildings, workplaces and homes, Fluke offers you a range of tools that monitor temperature, humidity, air velocity, particulate, and carbon monoxide levels. These tools help you to quickly and easily troubleshoot and maintain indoor air quality, as well as to verify the efficient operation of heating, ventilation and air conditioning systems.



975 AirMeter



Fluke 975

Combined inspection tool for complete air quality inspections

The Fluke 975 AirMeter combines five air monitoring tools into one, rugged and easy-to-use handheld tool. Use the Fluke 975 to verify the efficient operation of heating, ventilation and air conditioning systems, and test for dangerous carbon monoxide leaks in all types of buildings.

- Simultaneously measures, logs, and displays temperature, humidity, CO₂, and CO on a bright, backlit LCD display
- One-touch air flow and velocity measurements with available probe
- Min/Max/Average on all measured and calculated readings
- Audible and visual threshold alarms
- Multi-language user interface
- Extensive discrete or continuous data logging capacity, down-loadable to PC via USB interface

Specifications

(Check the Fluke web for detailed specifications)

Feature	Range	Display resolution	Accuracy
Measured specifications			
Temperature	-20 °C to 60 °C	0.1 °C	± 0.9 °C from 40 °C to 60 °C ± 0.5 °C from 5 °C to 40 °C ± 1.1 °C from -20 °C to 5 °C
Relative humidity	10 % to 90 % RH non-condensing	1 %	± 2 % RH (10 % RH to 90 % RH)
Air velocity	50 fpm to 3000 fpm 0.25 m/sec to 15 m/sec	1 fpm 0.005m/sec	4 % or 4 fpm* 3 % or 0.015 m/sec* whichever is greater *Accuracy specification only valid for velocity readings above 50 fpm.
CO ₂	0 to 5000 ppm	1 ppm	Warm up time 1 min (5 minutes for full specification) 2.75 % + 75 ppm
CO	0 to 500 ppm	1 ppm	± 5 % or ± 3 ppm, whichever is greater, @ 20 °C and 50 % RH
Calculated specifications			
Dew point temperature	-44 °C to 57 °C	0.1 °C	± 1 °C when temp: -20 °C to 60 °C RH: 40 % to 90 % ± 2 °C when temp: -20 °C to 60 °C RH: 20 % to 40 % ± 4 °C when RH: 10 % to 20 %
Wet bulb temperature	-16 °C to 57 °C	0.1 °C	± 1.2 °C when RH: 20 % to 90 % temp: -20 °C to 60 °C ± 2.1 °C when RH: 10 % to 20 %
Volume flow rate (in a duct)	0 to 3,965 M ³ /m 0 to 140,000 cfm)	0.001 M ³ /min (1 cfm)	N/A: The volume flow calculation will be a simple average of the data points times the duct area
% outside air (based on temperature)	0 to 100 %	0.1 %	N/A
% outside air (based on CO ₂)	0 to 100 %	0.1 %	N/A



Included Accessories

A4 alkaline batteries (3), Users Manual, Calibration Cap, FlukeView Forms Software, Power Adapter, International Power Plugs, Air Velocity Probe (Fluke 975V only)

Ordering Information

Fluke 975	AirMeter
Fluke 975V	AirMeter with Velocity
975R	Regulator
975VP	Air Velocity Probe

Operating temperature

(CO and CO₂ sensors): -20 °C to 50 °C

Operating temperature

(all other functions): -20 °C to 60 °C

Storage temperature: -20 °C to 60 °C

Humidity: 10% to 90%

Altitude: Up to 2000 m

Shock and vibration: MIL-PRF-28800F, Class 2

Battery: Rechargeable Li-Ion (primary), three-AA (backup)

Weight: 0.544 kg

Size (HxWxD): 28.7 cm x 11.43 cm x 5.08 cm

Data logging: 25,000 records (continuous), 99 records (discrete)

Multilanguage interface: English, French, Spanish, Portuguese and German

Two-year warranty

Recommended Accessories



975VP
AirMeter Velocity Probe

922 Airflow Meter



Fluke 922

Measures pressure, air flow and velocity for maintaining balanced and comfortable ventilation

The Fluke 922 makes airflow measurements easy by combining pressure, air flow, and velocity into a single, rugged meter. Compatible with most Pitot tubes, the Fluke 922 allows technicians to conveniently enter their duct shape and dimensions for maximum measurement accuracy.

- Provides differential and static pressure, air velocity and flow readings
- Convenient colored hoses help you properly diagnose pressure readings
- Bright, backlit display for clear viewing in all environments
- Min/Max/Average/Hold functions for easy data analysis
- Auto power off saves battery life

Use the Fluke 922 to: Ensure proper air flow balance and maintain a comfortable environment; measure pressure drops across filters and coils; match ventilation to occupant loads; monitor indoor vs. outdoor pressure relationships and manage the building envelope; and perform duct traversals for accurate airflow readings.

Specifications

(Check the Fluke web for detailed specifications)

Feature	Range	Resolution	Accuracy
Operating Specifications			
Air Pressure	± 4000 Pascals ± 16 in H ₂ O ± 400 mm H ₂ O ± 40 mbar ± 0.6 PSI	1 Pascal 0.001 in H ₂ O 0.1 mm H ₂ O 0.01 mbar 0.0001 PSI	± 1% +1 Pascal ± 1% + 0.01 in H ₂ O ± 1% + 0.1 mm H ₂ O ± 1% +0.01 mbar ± 1% + 0.0001 PSI
Air Velocity	250 to 16,000 fpm 1 to 80 m/s	1 fpm 0.001 m/s	± 2.5 % of reading at 10 m/s (2000 p/min)
Air Flow (Volume)	0 to 99,999 cfm 0 to 99,999 m ³ /hr 0 to 99,999 l/s	1 cfm 1 m ³ /hr 1 l/s	Accuracy is a function of velocity and duct size
Temperature	0 °C to 50 °C	0.1 °C	± 1 % + 2 °C

General Specifications

General specifications	
Operating Temperature	0 °C to +50 °C
Storage Temperature	-40 °C to +60 °C
Operating Relative Humidity	Non condensing (<10 °C) 90% RH (10 °C to 30 °C) 75% RH (30 °C to 40 °C) 45% RH (40 °C to 50 °C) Without Condensation
IP Rating	IP40
Operating Altitude	2000 m
Storage Altitude	12000 m
EMI, RFI, EMC	Meets requirements for EN61326-1
Vibration	MIL-PREF-28800F, Class 3
Max Pressure at Each Port	10 PSI

Data Storage: 99 readings
Size (HxWxD): 175 x 775 x 419 mm
Weight: 0.64 kg
Battery: Four AA batteries
Battery Life: 375 hours without backlight,
80 hours with backlight
Two Year Warranty



Fluke 922/Kit

Recommended Accessories

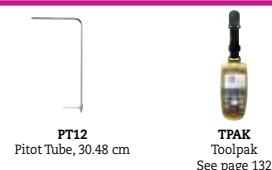

PT12
Pitot Tube, 30.48 cm

TPAK
Toolpak
See page 132



Included Accessories

Fluke 922: Two Rubber Hoses, Wrist Strap, Four AA Batteries 1.5 V Alkaline, Users Manual and Soft Carrying Case

Fluke 922 Kit Includes: Fluke 922 Airflow Meter, 30.48 cm Pitot tube, ToolPak, Two Rubber Hoses, Wrist Strap, Four AA Batteries 1.5 V Alkaline, Users Manual and Hard Carrying Case

Ordering Information

Fluke 922 Air Flow Meter
 Fluke 922/Kit Airflow Meter with
 30.48 cm Pitot Tube

971 Temperature Humidity Meter Carbon Monoxide Meters

FLUKE®



Fluke 971

Fluke 971 Temperature Humidity Meter

Quickly take accurate humidity and temperature readings in the air. Temperature and humidity are two important factors in maintaining optimal comfort levels and good indoor air quality. The Fluke 971 is invaluable for facility maintenance and utility technicians, HVAC-service contractors, and specialists who assess indoor air quality (IAQ). Lightweight, rugged, and easy to hold, the Fluke 971 is the perfect tool for monitoring problem areas.

- Simultaneously measures humidity and temperature
- Measures dew point and wet bulb
- 99 record storage capacity
- Min/Max/Avg Data Hold
- Ergonomic design with built-in belt clip and protective holster
- Backlit, dual readings display
- Twist-open protective cap
- Low battery indicator

Specifications

Temperature range	-20 °C to 60 °C
Temperature accuracy	
0 °C to 45 °C	± 0.5 °C
-20 °C to 0 °C and 45 °C to 60 °C	± 1.0 °C
Resolution	0.1 °C
Response time (temperature)	500 ms
Temperature sensor type	NTC
Relative humidity range	5% to 95% R.H.
Relative humidity accuracy	
10% to 90% R.H. @ 23 °C	± 2.5 % R.H.
<10%, >90% R.H. @ 23 °C	± 5.0 % R.H.
Humidity sensor	Electronic capacitance polymer film sensor
Data storage	99 points
Response time (humidity)	For 90% of total range - 60 sec with 1 m/s air movement

Other useful tools



Fluke 561
Combined Contact
and Non-contact
Thermometer
See page 54.



Fluke 416D
Laser Distance Meter
See page 74 .

Operating temperature:

Temperature: -20 °C to 60 °C
Humidity: 0 °C to 60 °C

Storage temperature: : -20 °C to 55 °C

Battery life: 4 AAA alkaline, 200 hours

Safety: Complies with EN61326-1

Weight: 0.188 kg

Size (HxWxD): 194 mm x 60 mm x 34 mm

One Year Warranty

Carbon Monoxide Meters

CO-220 Carbon Monoxide Meter

The CO-220 Carbon Monoxide Meter makes it easy to take quick and accurate measurements of CO levels. A large, backlit LCD display shows CO levels from 0 to 1000 PPM. The MAX Hold function stores and displays the maximum CO level. 1 year warranty.



Fluke CO-220

Included Accessories

Fluke CO-220: C50 soft carrying case and battery

Ordering Information

Fluke 971 Temperature Humidity Meter
Fluke CO-220 Carbon Monoxide Meter
CO-205 Aspirator Kit

CO-205 Aspirator Kit

Allows flue gas samples up to 371°C to be drawn with the CO-220 for carbon monoxide measurement. 1 year warranty.



Fluke CO-205

983 Particle Counter / RLD2 Leak Detector Flashlight

FLUKE®



Fluke 983

Easy to use tool for troubleshooting and maintaining indoor air quality

The Fluke 983 Particle Counter simultaneously measures and displays six channels of particle size distribution, temperature and humidity. This compact, lightweight, self-contained tool allows for one-handed operation. As the Fluke 983 doesn't require level holding, it can make accurate measurements in any position. The 8 hour rechargeable battery together with a large 5000 sample record allows for complete air quality surveys in one go. The Fluke 983 is the ideal tool for determining size distribution of airborne particles or tracking down a particle source.

- Simultaneously measure and display 6 channels of particle sizes, temperature and humidity
- Measure particle size down to 0.3 µm
- Selectable sample time, count data, programmable delay
- Store 5000 records of date, time, counts, relative humidity, temperature, sample volumes, alarms and location label
- Upload stored data to a PC with included software
- Compact, self-contained package allows for one-handed operation
- Intuitive, easy-to-use user interface
- Always ready to run, with no fluids to refill
- Backlit LCD for use in any lighting condition

Specifications

6 size channels	0.3, 0.5, 1.0, 2.0, 5.0, 10.0 µm
Flow rate	0.1 cfm (2.83 L/min) controlled by internal pump
Count modes	Concentration, totalize, audio
Counting efficiency	50 % @ 0.3 µm; 100 % for particles > 0.45 µm (per JIS B9921:1997)
Zero count	1 count/5 minute (per JIS B9921:1997)
Coincidence loss	5 % at 56,000 particles per m ³
Relative humidity	± 7 %, 20 % to 90 %, non-condensing
Temperature	± 3 °C, 10 °C to 40 °C
Data storage	5000 sample records (rotating buffer) of date, time, counts, relative humidity, temperature, sample volumes, alarms, label
Alarms	Counts, low battery, sensor fail
Delay time	0 to 24 hours
Sample inlet	Isokinetic probe
Interface	RS-232 and RS-485 via RJ-45
Calibration	PSL particles in air (NIST traceable)

Operating temperature: 10 °C to 40 °C, 20 % to 90 % relative humidity, non-condensing
Storage temperature: -10 °C to 50 °C, up to 90 % relative humidity, non-condensing
Power: AC adapter, 90 to 250 V AC, 50 to 60 Hz
Battery life/recharge time: 8 hours/2 hours

Rechargeable battery: NiMH, 4.8V at 4.5 Ah; replaceable
Size (HxWxD): 209 mm x 114 mm x 57 mm
Weight: 1 kg
Warranty: 1 year

Included Accessories

Fluke 983:
 Certificate of Calibration (NIST)
 Isokinetic probe
 Zero count filter
 Windows-compatible software download utility
 DB9 to RS-232 adapter and cable
 High purity tubing
 1/8 in. hose barb adapter
 Power supply
 Operation manual
 Hard molded carrying case
 Fluke RLD2: Key chain carabiner and batteries.

Ordering Information

Fluke 983 Particle Counter
 Fluke RLD2 Leak Detector Flashlight

RLD2 Leak Detector Flashlight



RLD2 Leak Detector Flashlight.

Leak detection made easy. The compact RLD2 uncovers refrigerant leaks instantly. Use the UV light to find the leakage area, then, use the laser pointer to pinpoint the exact leak location.

- Six UV LEDs detect leak detection dyes
- Laser pointer clearly locates center of the UV field for accuracy
- Three LED flashlight with 100,000 hour LED life
- Operating temperature 0°C to 50°C
- Four operating modes: flashlight, UV light, laser light, UV/laser light combination
- One year warranty

ScopeMeter® Test Tools

ScopeMeter portable oscilloscopes take you into territory standard bench scopes can't go: where it's harsh, hazardous and dirty – without sacrificing any capabilities. They provide you with unmatched speed, performance and analysis power while working on site.



ScopeMeter 190 Series II

New



The toughest portable scopes ever built

Combining rugged portability with the performance of a bench scope, the Fluke 190 Series can take you from troubleshooting microelectronics all the way into power electronic applications. See more, fix more and go where you've never gone with a scope before.

The first high-performance two and four Channel scopes built for harsh industrial environments.

Introducing the first high-performance portable oscilloscopes with 2 or 4 independently insulated input channels, an IP51 dust- and drip waterproof rating and a CAT III 1000 V / CAT IV 600 V safety rating. Choose from 500 MHz, 200 MHz, 100 MHz or 60 MHz bandwidth models.

Now plant maintenance engineers can take a four-channel scope into the harsh world of industrial electronics. Safely troubleshoot three-phase systems like variable speed drives, UPS or back-up generators. Measure input, output and feedback signals simultaneously to diagnose industrial electronics.

- 4 independent isolated input channels enable 3-axis industrial testing, simultaneous testing of input signals, output signals and feedback loops or safety interlocks
- 190-XX4 model with four independent isolated inputs
- 190-XX2 models with two independent isolated scope inputs and DMM input
- Fast sample rate: up to 5 GS/s with up to 200 ps resolution
- Single shot, pulse width and video triggering
- Deep memory: 10,000 points per trace waveform capture
- CAT III 1000 V / CAT IV 600 V, safety rated
- Up to seven hours of operation with high performance Li-ion batteries, that extend usage time plus optional external charger
- Battery door for conveniently swapping out
- Two isolated USB ports, for memory devices and PC connectivity
- Security slot to lock down instrument using standard Kensington® lock
- Connect & View™ triggering for intelligent, automatic triggering on fast, slow and even complex signals
- Frequency Spectrum using FFT analysis
- Automatic capture and REPLAY of 100 screens
- ScopeRecord™ mode gives 30000 points or more per input channel for low frequency signal analysis
- TrendPlot™ paperless recorder mode with deep memory for long-term automatic measurements

What could you do with four channels?

Take multiple measurements simultaneously to track down the root cause of your most complex troubleshooting challenges.

- Easily diagnose timing-related issues with multiple signals
- Real-time inspection of multiple signals simultaneously
- Measure a combination of input and output signals and system safety interlocks and feedback loops

Fluke 190-502 brings wide bandwidth test applications in the palm of your hand!

With the new 500 MHz model, the verification of telecommunication equipment, high frequency and wide bandwidth systems such as radar equipment has become truly portable. Conveniently verify the systems performance right 'on the spot', fully safely without carrying bulky lab equipment around. Battery powered and fully floating – up to 600V CAT III, for each channel and in between channel references.

Application driven

Find problems in industrial systems including:

- Circuit voltage/current overloading
- Attenuation/input impedance mismatch
- Signal fluctuation/drift
- Conditioning circuits signal integrity
- Test point verification for critical signals
- Input/output/feedback timing issues
- Induced noise and disturbances
- Random shutdowns/reset

Diagnose VSDs* or power inverters and converters

- Harmonics, transients and loads in three phase power input
- Troubleshoot dc to ac converters for faulty control circuits or output IGBT gate stages
- Cable interface - test PWM output for reflections and transients
- Vpwm measurement to measure the effective voltage on drive outputs

Technologies	Electrical	Electromechanical	Process Controls	Automation	Medical Imaging	Avionics	A/V & Security Systems
Equipment	Switch Gear, Interlocks, Motors, Pumps, Fans, Furnaces, Presses, Mixers, Refrigeration	Actuators, VFD Drives, Linear Motors, Pressure-Level-Flow-Position Sensors, Packaging Equipment	Transducers, Sensors, Loop Controllers, Calibrated Gauges	PLC's, Sensors, Transducers, Motion Controllers, Rotary Encoders, Scanners, Readers, Printers	XRay, MRI, Ultrasound Imaging equipment	Flight Line Navigation Systems, Communication systems, Radar, On board aircraft control systems	Retail security devices, Surveillance and monitoring equipment, RFID

ScopeMeter 190 Series II

New



Fluke 190-204



Fluke 190-202



True RMS

Multiply your diagnostic powers with the new Fluke 190 Series II portable oscilloscopes

Rated all the way to CAT IV

ScopeMeter test tools are rugged solutions built for industrial troubleshooting. The new Fluke 190 Series II are double-insulated floating oscilloscopes safety rated for measurements up to CAT III 1000 V/CAT IV 600 V environments. The new 500 MHz model is rated all the way up to 600 V CAT III.

Measure from mV to kV safely

Independently isolated inputs allow you to make measurements in mixed circuits having different ground references reducing the risk of accidental short circuits. Conventional bench oscilloscopes without special differential probes and isolation transformers can only reference measurements to line power earth ground. With standard probes that cover a wide application range from mV to kV, you are ready for anything from micro-electronics to heavy-duty higher voltage electrical applications.

IP-51 rated for harsh environments

Rugged and shock-proof, ScopeMeter portable oscilloscopes are built for dirty, hazardous environments. With its sealed case, it can endure dust, drips, humidity and airborne pollutants. Every time you reach for ScopeMeter you can be confident it will work reliably wherever your work takes you.

USB connectivity makes it easy to capture and share waveforms

The new Fluke 190 Series II offers two USB ports, electrically isolated from measurement input circuits. Easily transfer data to a PC. Archive and share waveforms with OEMs, colleagues and support staff. Store waveforms, screen captures and instrument setups onto USB memory devices.



Optional Accessories

C290	Hard shell protective carrying case for 190 Series II
HH290	Hanging Hook for 190 Series II instruments
SCC290	FlukeView Software (full version) and C290 Carrying Case kit
VPS410-R	Voltage Probe set, 10:1, 300 MHz, one set red
VPS410-G	Voltage Probe set, 10:1, 300 MHz, one set grey
VPS410-B	Voltage Probe set, 10:1, 300 MHz, one set blue
VPS410-V	Voltage Probe set, 10:1, 300 MHz, one set green
VPS420-R	High working voltage probe set 150 MHz, 100:1, CAT III 2000 V (1000 V to earth)
BC190	Mains adapter/battery charger
EBC290	External battery charger for BP290 and BP291
TL175	TwistGuard™ safety designed Test Leads set (1 red, 1 black)
BP290	Li-Ion battery pack, 2400 mAh
BP291	Li-Ion battery pack, 4800 mAh
SW90W	FlukeView® ScopeMeter Software for Windows®
VPS510-X	Wide bandwidth probe set, 10:1, 500 MHz, 600V CAT III

FlukeView ScopeMeter software for documenting, archiving and analysis

Get more out of your ScopeMeter with FlukeView® ScopeMeter® SW90W Software for Windows.

- Documentation—transfer waveforms, screens and data to your PC for printing or importing data into a report
- Add text to ScopeMeter settings—give operators guidance when recalling settings
- Archive—create a library of waveforms for easy reference, waveform comparison, or pass/fail testing
- Analysis—use cursors, perform spectrum analysis or export data to another analysis program

ScopeMeter 190 Series II



A range of application notes is available. See the Fluke website.

Connect-and-View™ triggering for an instant, stable display

If you've used other scopes, you know how tricky triggering can be. If settings are incorrect, results can be unstable or incorrect. Connect-and-View™ automatically sets up correct triggering by recognizing signal patterns. Without touching a button, you get a stable, reliable and repeatable display of virtually any signal including motor drive and control signals. It's especially fast and convenient when you're measuring a number of test points in rapid succession.



Connect-and-View™ captures even the most complex motor drive signals.

Built-in digital multimeter (2 channel models)

190 Series II models with isolated dual input scope and dedicated digital multimeter. Conveniently switch from waveform analysis to precise multimeter measurements using the built in 5000 count digital multimeter. Measurement functions include Vdc, Vac, Vac+dc, resistance, continuity and diode test. Measure current and temperature using suitable shunt, probe or adapter with wide range of scaling factors.



The built in multimeter provides convenient precision measurements.

Included Accessories

Fluke 190 Series II 4-channel instruments include a set of four probes, hanging strap, handstrap, USB cable with mini-B connector, double capacity Li-ion battery BP291, battery charger/power adapter BC190, a FlukeView demo package and users manuals on CD-ROM. The /S-versions also include the C290 hard-shell carrying case and the FlukeView software package. The 2-channel models come with two probes plus a set of TL175 test leads and a single capacity battery BP290. The 190-502 also includes two pieces TRM50 coaxial feedthrough terminator. The SCC290 kit includes: C290 hardshell carrying case and FlukeView® for Windows® software (full version).

Ordering Information

Fluke-190-502/S	Color ScopeMeter (500 MHz, 2 channel), with SCC290-kit
Fluke-190-204/S	Color ScopeMeter (200 MHz, 4 channel), with SCC290-kit
Fluke-190-204	Color ScopeMeter (200 MHz, 4 channel)
Fluke-190-202/S	Color ScopeMeter (200 MHz, 2 channel), with SCC290-kit
Fluke-190-202	Color ScopeMeter (200 MHz, 2 channel)
Fluke-190-104/S	Color ScopeMeter (100 MHz, 4 channel), with SCC290-kit
Fluke-190-104	Color ScopeMeter (100 MHz, 4 channel)
Fluke-190-062/S	Color ScopeMeter (60 MHz, 2 channel), with SCC290-kit
Fluke-190-062	Color ScopeMeter (60 MHz, 2 channel)
AS400	Probe Accessory Extension set for VPS400 Series probes
BP291	Double capacity Li-Ion battery (4800 mAh) pack for 190C Series II
BP290	Single capacity Li-ion battery (2400 mAh) pack for 190-series II
C195	Soft padded carrying case for ScopeMeter and accessories
C290	Protective Carrying Case for Fluke 190-series II
EBC290	External Battery Charger for charging BP290 or BC291 outside the instrument
HH290	Hanging Hook
RS400	Probe Accessory Replacement set for VPS400 series probes
RS500	Probe Accessory Replacement set for VPS510 series probes
SCC290	Software and Case kit for Fluke 190 Series 190 Series II. Includes SW90W and C290.
SW90W	FlukeView® ScopeMeter Software for Windows® (full version)
TRM50	Coaxial 50 Ω feedthrough terminator
VPS410-x	Probe-set, 10:1, 1000V CAT III / 600V CAT IV (colors: blue, green, red, grey)
VPS420-R	Probe-set, bicolor (r/b), 100:1, 150 MHz, 1000V CAT III / 600V CAT IV, working voltage (voltage between probe tip and reference lead): 2000V CAT III / 1200V CAT IV.
VPS510-x	Wide bandwidth probeset, 500 MHz, 10:1, 600V CAT III

Automatic capture and replay op 100 screens

Scope users know how frustrating it is to see a one-time anomaly flash by, never to be seen again. Not with the ScopeMeter 190-series! Now you can look back in time with the touch of a button. In normal use, the instrument continuously memorizes the most recent 100 screens. At any moment in time, you can 'freeze' these latest screens and scroll through them picture-by-picture or replay them as a 'live' animation. Cursors and zoom can be used for further analysis. You can even use the advanced trigger capabilities to capture up to 100 specific events. Two sets of 100 screens with individual time stamps can be stored for later recall or download to a PC.



See dynamic signal behavior instantly

The digital Persistence mode helps to find anomalies and to analyze complex dynamic signals by showing the waveforms amplitude distribution over time using multiple intensity levels and user selectable decay time - it's as if you're looking at the display of an analog, real time oscilloscope! A fast display update rate reveals signal changes instantaneously, useful for instance when making adjustments to a system under test.

Recommended Accessories



ScopeMeter® 120 Series



Fluke 125



Fluke 124



Fluke 123



Three-in-one simplicity

The compact ScopeMeter 120 Series is the rugged solution for industrial troubleshooting and installation applications. It's a truly integrated test tool, with oscilloscope, multimeter and "paperless" recorder in one affordable, easy-to-use instrument. Find answers to problems in machinery, instrumentation, control and power systems quickly and easily.

- Dual-input 40 MHz or 20 MHz digital oscilloscope
- Two 5,000 counts true-RMS digital multimeters
- A dual-input TrendPlot™ recorder
- Bus Health Test for industrial bus systems (Fluke 125)
- Connect-and-View™ trigger simplicity for hands-off operation
- Power Measurements and Harmonics measurement (Fluke 125)
- Shielded test leads for oscilloscope, resistance and continuity measurements
- Up to 7 hours battery operation
- 600 V CAT III safety certified
- Optically isolated interface for PC and Printer connection (optional)
- Rugged, compact case

Connect-and-View™ triggering for an instant, stable display

Scope users know how difficult triggering can be. Wrong settings show unstable and sometimes wrong results. Fluke's

unique Connect-and-View recognizes signal patterns, and automatically sets up correct triggering. It provides a stable, reliable and repeatable display of virtually any signal - including motordrive and control signals - without touching a button. Signal changes are instantly recognized and settings adjusted for - once again - a stable display.

Use TrendPlot™ to help find intermittents fast

The toughest faults to find are those that happen only once in a while: intermittents. They can be caused by bad connections, dust, dirt, corrosion or simply broken wiring or connectors. You may not be around to see it - your Fluke ScopeMeter will. In this "paperless recorder" mode, you can plot the minimum and maximum peak values and average over time - up to 22 days (Fluke 190 Series) or 16 days (Fluke 120 Series).

Bus Health mode (Fluke 125)

Bus Health mode gives a clear "Good/Bad" indication for the electrical signals on industrial buses and networks, such as CAN-bus, Profi-bus, RS-232 and many more. The Fluke 125 validates the quality of the electrical signals as soon as any electrical signals are passed along the network.

Included Accessories

PM 8907 line adapter/charger, STL120-III shielded test leads set (1 red, 1 grey) including hook clips, BB120 shielded BNC adapter, BP120MH NiMH battery pack, VPS40-III wide bandwidth Voltage Probe (Fluke 124/125), TL175 Safe-guard testlead, i400s current clamp (Fluke 125), Getting Started booklet, user's manual (cd-rom)

Ordering Information

Fluke 123	Industrial ScopeMeter® (20MHz)
Fluke 123/S	Industrial ScopeMeter® (20MHz) + SCC120 kit
Fluke 124	Industrial ScopeMeter® (40MHz)
Fluke 124/S	Industrial ScopeMeter® (40MHz) + SCC120 kit
Fluke 125	Industrial ScopeMeter (40 MHz)
Fluke 125/S	Industrial ScopeMeter (40 MHz) + SCC120 kit
SCC120	FlukeView® Software + OC4USB Cable + Carrying Case
OC4USB	USB Interface Cable
PM9080	RS-232 Interface Cable
DP120	Differential Voltage Probe
ITP120	Isolated Trigger Probe
SW90W	FlukeView Software
BHT190	Set of 3 break-out adapters (Fluke 125)

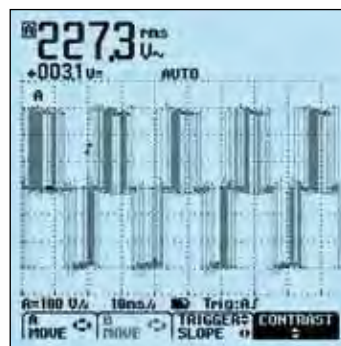

Connect-and-View captures even the most complex motor drive signals.

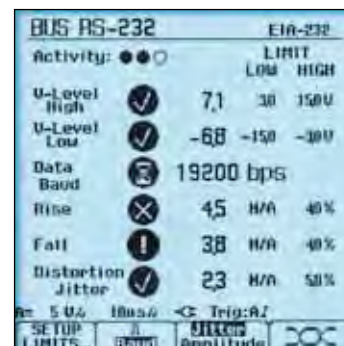

Bus Health mode allows for an analysis of the signal quality on an industrial network.

See page 85 for specifications.

Recommended Accessories



SCC120



C125
See page 124



DP120
See page 86



OC4USB
See page 86



SCC128
See page 125

ScopeMeter Test Tools



Fluke 225C/S Industrial Networks and Bus Health Test

Built on the Fluke 190C-series, the 225C/S makes Bus Health Test analysis on the electrical signals on an industrial bus or network, giving a clear “Good”, “Weak” or “Bad” validation of the relevant parameters, presented next to the actual measurement value. The Fluke 225C/S can make the signal quality validation as soon as electrical signals are passed along the network, without looking at the data content. It finds errors like improper cable connections, bad contacts, incorrect grounding and missing or superfluous terminators.

Included Accessories

- BHT190 Set of three break-out adapters for industrial networks
- BC190 Mains adapter/Battery charger
- BP190 NiMH battery pack (installed)
- VPS210 Voltage probe sets (1 red, 1 grey)
- TL175 SafeGuard(r) Testlead set
- C190 Hard shell protective carrying case
- OC4USB Optically insulated USB interface cable for PC connectivity
- SW90W FlukeView software package (full version)

Ordering Information

- 225C/S Color ScopeMeter (200 MHz, 2.5 GS/s) with Bus Health Test capabilities and SCC-kit.



Typical status overview of a bushealth measurement.

General ScopeMeter Specifications

Model:	190-502	190-204	190-202	190-104	190-102	190-062	225C/S	125	124	123
Oscilloscope Specifications										
Bandwidth	500 MHz	200 MHz		100 MHz	60 MHz	200 MHz		40 MHz		20 MHz
Max. real time sample rate	5 GS/s	2.5 GS/s		1.25 GS/s	625 MS/s	2.5 GS/s		25 MS/s		
Input sensitivity	2 mV/div.							5 mV/div.		
Max. timebase speed	1 ns/div.	2 ns/div.		4 ns/div.	10 ns/div.	5 ns/div.		10 ns/div.		20 ns/div.
Inputs and digitizers	2 + Ext.Tr.	4	2 + Ext.Tr.	4	2 + Ext.Tr.	2 + Ext.Tr.	2 + Ext.Tr.	2 (+ Ext.Trig. Optional)		
Independently floating isolated inputs	600 V CAT III			1000 V CAT III, 600 V CAT IV			600 V CAT III			
Max. record length	10 000 samples per trace							512 min/max pairs per input		
.... In Scope mode	30 000 min/max pairs									
.... In ScopeRecord mode							3000	27500		
Glitch capture	8 ns peak detect at full timebase range						50 ns	40 ns		
True RMS multimeter built-in (5000 counts)	yes	-	yes	-		yes		dual 5000 counts DMM		
Dedicated test capabilities	V/Hz ratio	-	V/Hz ratio	-		V/Hz ratio	Bus health test			
General Specifications										
Mains adapter/battery charger incl. (type)	BC 190							PM8907		
Battery installed	BP291	BP291	BP290	BP291	BP290	BP290	BP190	BP120MH		
Size	265 x 190 x 70 mm						**	232 x 115 x 50 mm		
Weight	2.1 kg	2.2 kg	2.1 kg	2.2 kg		2.1 kg	2 kg	1.2 kg		
Safety certified	1000 V CAT III / 600 V CAT IV							600 V CAT III		

ScopeMeter® Accessories



VPS410-X



VPS420-R



VPS510-x



STL120-III



VPS40-III

ScopeMeter series	190-series II			120-series		
	VPS410-x	VPS420-R	VPS510-x	STL120-III	VPS40-III	DP120
Description	Voltage probe	High working voltage probe*	Wide bandwidth voltage probe	Shielded Test leads	Voltage probe	Differential Voltage Probe
Colors available	red, grey, blue, green	bicolor (red & black)	red, grey, blue, green	red + grey (1 set)	black	red + grey (1 set)
Attenuation	10:1	100:1	10:1	1:1	10:1	200:1 / 20:1
Bandwidth	300 MHz	150 MHz	500 MHz	12.5 MHz	40 MHz	20 MHz
Length	1.2 m	1.2 m	1.2 m	1.2 m	1.2 m	1.5 m (2x)
Safety Rating CAT II	--	--	--	1000 V	1000 V	1000 V
Safety Rating CAT III	1000 V	1000 V*	300 V	600 V	600 V	600 V
Safety Rating CAT IV	600 V	600 V*	--	--	--	--

* High Working Voltage Probe is specified for working voltages (between probe tip and reference lead) up to 2000V in CAT III or 1200V in CAT IV environments. Reference lead voltage (between reference lead and earth ground): 1000V in CAT III, 600V in CAT IV. These specification applies only when used with Fluke 190-series II Test Tool.



PM9091/9092



PM9081



PM9082



PM9093



DP120

	PM9091	PM9092	PM9081	PM9082	PM9093
Description	Safety designed 50 Ω BNC Cable set (1 red, 1 black, 1 grey)		Dual banana plug (m) to female BNC	Dual banana jack (f) to BNC plug (m)	BNC (m) to dual BNC (f) 'T-piece'
Length	1.5 m each	0.5 m each	--	--	--
Safety Rating CAT III	300 V	600 V	600 V	600 V	10:1



RS400



AS400



BP291



OC4USB



EBC290

RS400	Probe Accessory Replacement set for VPS200 and VPS400 series probes
AS400	Accessory Extension set for VPS200 and VPS400 series probes
PM9080	RS232 interface cable for 120-series
OC4USB	Optocoupler to USB interface cable for 120 series
BP120MH	Ni-MH battery pack for Fluke 120-series and Fluke 43B
BP290	Single capacity Li-ion battery pack for 190-series II
BP291	Double capacity Li-ion battery pack for 190-series II
EBC290	External battery charger for BP290 and BP291
TRM50	Coaxial 50 Ω feedthrough terminator
RS500	Probe Accessory Replacement set for VPS510 series probes
C437-II	Hard shell protective carrying case with rollers for 190-II and 430-II
RF-AM90	RF Detector and Demodulation probe

Power Quality Tools and Power Analyzers

We offer an extensive range of power quality test tools for troubleshooting, predictive maintenance and long-term recording in industrial and utility applications. For the development and test of electrical equipment, our high-precision power analyzers enable easy and reliable use in the field or as a bench unit in test laboratories. Additionally, the Fluke-patented energy loss algorithm, Unified Power Measurement, measures and quantifies energy losses due to harmonics and unbalance issues, allowing the user to pinpoint the origin of energy waste within a system.

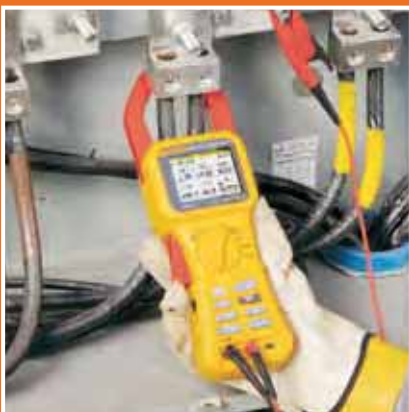

Power Quality Selection Guide

Power quality tools help pinpoint problems fast

		VR1710	Single phase	433B	430 II	1735	Three phase	1740	1750	1760
			345							
Basic measurements	Application use									
RMS voltage	Detailed RMS trending shows how connected loads behave.	●	●	●	●	●	●	●	●	●
RMS Current		●	●	●	●	●	●	●	●	●
Energy studies										
Measure V, I, kW, Cos/DPF, kWhr	Get detailed power and energy consumption profiles during energy audits and pinpoint savings opportunities.	●	●	●	●	●	●	●	●	●
Measure MIN/MAX and AVG values		●	●	●	●	●	●	●	●	●
10 day logging		●	●	●	●	●	●	●	●	●
Energy aggregation		●	●	●	●	●	●	●	●	●
Utility meter pulse input		●	●	●	●	●	●	●	●	●
Energy Loss (Eff, kW, Reactive kVAR, Unbalance kVAR, Distortion kVAR, Neutral kVAR)		●	●	●	●	●	●	●	●	●
Energy loss calculator		●	●	●	●	●	●	●	●	●
Basic harmonics study										
THD measurement (V & I)	Discover the source of distortion in your installation, so that you can filter those loads or move them to separate circuits.	●	●	●	●	●	●	●	●	●
Harmonics 1 to 25 for V & I		●	●	●	●	●	● (not 1743)	●	●	●
Tabular values		●	●	●	●	●	●	●	●	●
Neutral current measurement		●	●	●	●	●	●	●	●	●
Crest factor		●	●	●	●	●	●	●	●	●
Advanced harmonics study										
Full harmonic spectrum	If distorting loads are causing problems in your installation, you need comprehensive data to identify the source and create a solution.	●	●	●	●	●	●	●	●	●
Power harmonics		●	●	●	●	●	●	●	●	●
Harmonics 1 to 50 and dc		●	●	●	●	●	● (not 1743)	●	●	●
k-factor		●	●	●	●	●	●	●	●	●
%Fundamental and %RMS		●	●	●	●	●	●	●	●	●
Basic Industrial PQ Troubleshooting										
Oscilloscope function	When troubleshooting in the field, graphical data enables you to trace the source of the problem at hand.	●	●	●	●	●	●	●	●	●
Voltage dips and swells		●	●	●	●	●	●	●	●	●
Phasor diagram		●	●	●	●	●	●	●	●	●
Trend recording		●	●	●	●	●	●	●	●	●
Inrush current		●	●	●	●	●	●	●	●	●
Advanced Industrial PQ troubleshooting										
Comprehensive logging capability	Complex installations often require a deeper dive into measurement data. Multiple loads may be interacting randomly to cause a single problem.	●	●	●	●	●	●	●	●	●
Transient capture		●	●	●	●	●	●	●	●	●
Flicker		●	●	●	●	●	●	●	●	●
EN50160 analysis		●	●	●	●	●	●	●	●	●
Complex System interaction event capture (manual threshold setting)		●	●	●	●	●	●	●	●	●
Random/variable system event capture (Adaptive threshold setting)		●	●	●	●	●	●	●	●	●
400 Hz		●	●	●	●	●	●	●	●	●
Utility PQ benchmarking										
Phase sequence components	Before you install sensitive loads, make sure you understand the existing quality of power delivered by your utility. Comparing benchmarks over time can help pinpoint potential areas of concern.	●	●	●	●	●	●	●	●	●
Interharmonics		●	●	●	●	●	●	●	●	●
Mains signaling		●	●	●	●	●	●	●	●	●
IEC61000-4-30 Class A		●	●	●	●	●	●	●	●	●
Software										
Power Log	To make use of the power data you collect, you need software that can help analyze your findings and share them with equipment providers and plant management.	●	●	●	●	●	●	●	●	●
PQ Log		●	●	●	●	●	●	●	●	●
Power Analyze		●	●	●	●	●	●	●	●	●
PQ Analyze		●	●	●	●	●	●	●	●	●
FlukeView Forms		●	●	●	●	●	●	●	●	●
FSD card (max 32 GB)		●	●	●	●	●	●	●	●	●
										8 GB

345 Power Quality Clamp Meter

FLUKE®



Fluke 345



View waveforms for equipment checking and setup

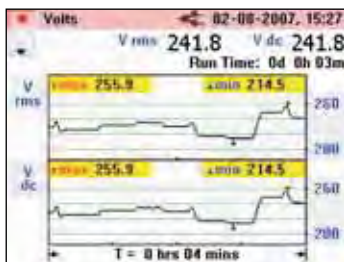

Log parameters over time to track down intermittent faults



The ideal troubleshooting tool for modern electrical loads

The Fluke 345 measures a wide range of electrical parameters for troubleshooting power disturbances in single- and three-phase electrical loads. With a bright color display to see waveforms and trends, a low-pass filter to remove high frequency noise, and a high EMC immunity design, the Fluke 345 is ideal for measurements on switching loads such as variable speed drives, electronic lighting and UPS systems.

- **High safety rating:** 600V CAT IV / 1000V CAT III rated for use at the service entrance
- **ac/dc current measurements:** Clamp-on measurement of ac peak and dc current up to 2000 A without breaking the circuit
- **Harmonic analysis:** Analyze, display and log harmonics up to the 30th harmonic (40th harmonic for 15 Hz to 22 Hz)
- **Verify batteries:** Direct measurement of dc ripple (%) for battery and dc systems

Specifications

(Check the Fluke web for detailed specifications)

Current measurement	
DC, DC rms, AC rms	All measurements DC and 15 Hz to 1 kHz. Maximum overload 10,000 A or RMS x frequency < 400,000. Amps rms is a true rms measurement (AC + DC).
Measuring range	0 - 2000 A dc or 1400 AC rms
Harmonics	All measurements up to 30th harmonic (40th harmonic for 15 Hz to 22 Hz); Frequency range F0 : 15 Hz to 22 Hz and 45 Hz to 65 Hz; Iacrms > 10A
Voltage measurement	
DC, DC rms, AC rms	All measurements DC and 15 Hz to 1 kHz. Maximum overload 1,000 V rms. Volts rms is a true-rms measurement (AC + DC).
Measuring range	0 - 825 V DC or AC rms
Harmonics	All measurements up to 30th harmonic; Frequency range F0 : 15 Hz to 22 Hz and 45 Hz to 65 Hz; Vacrms > 1V
Watts measurement (single- and three-phase)	DC, DC rms, AC rms
Measuring range	0 - 1650 kW DC or 1200 kW ac
VA measurement (single- and three-phase)	DC, DC rms, AC rms
Measuring range	0 - 1650 kVA DC or 1200 kVA ac
VAR measurement (single- and three-phase)	
Measuring range	0 - 1250 kVAR
Power factor (single- and three-phase)	
Measuring range	0.3 cap...1.0... 0.3 ind (72.5° cap...0°... 72.5° ind)
Displacement power factor	
Measuring range	0.3 cap ... 1.0 ... 0.3 ind (72.5° cap ... 0° ... 72.5° ind)
Kilowatt Hour (kWhr)	
Measuring range	40,000 kWhr
Scope function	
Time base	2.5 ms, 5 ms, 10 ms, 25 ms, 50 ms/div
Current management:	
Ranges	10 A/20 A/40 A/100 A; 200 A/400 A/1000 A/2000 A
Voltage measurement:	
Ranges	4 V/10 V/20 V/40 V/100 V; 200 V/400 V/1000 V
Inrush current function	
Ranges	All measurements dc and 15 Hz to 1 kHz
Memory	Up to 50 screen shots and over 150,000 individual measurement values

Power supply: 1.5 V Alkaline AA MN 1500 or IEC LR6 x 6 Battery

Battery life (typical): >10 hours (backlight on full); >12 hours (backlight reduced)

Safety: IEC 61010-1 600 V CAT IV, 1000V CAT III (maximum input phase-phase 825V rms) double or reinforced insulation, pollution degree 2

Protection: IP40; EN60529

Operating temperature: 0 °C to 50 °C

Display: Color transmissive LCD 320 x 240 pixels (70 mm diagonal) with 2 level backlight

Digital output: USB interface to a PC

Size (HxWxD): 300 mm x 98 mm x 52 mm

Jaw opening: 60 mm

Jaw capacity: 58 mm diameter

Weight (including batteries): 0.82 kg

Two Year Warranty

Included Accessories

Soft carrying case, Power Log software, Test probes, Test leads, Alligator clips, International ac adapter / battery eliminator, Printed English User manual, Multi-language manual on CD

Ordering Information

Fluke 345 Power Quality Clamp Meter

Recommended Accessories



TLK291
See page 123



TP220-1
See page 123



AC220
See page 124



TP1-1
See page 123



C550
See page 130

43B Single-phase Power Quality Analyzer

FLUKE®



Fluke 43B

The perfect tool for tracking down single-phase power-related problems

The Fluke 43B is the choice for diagnosing and troubleshooting power quality and general equipment failures. Ease of use thanks to menu selection of the power modes, it combines the

capabilities of a power quality analyzer, a 20 MHz oscilloscope, a multimeter and a data recorder in a single instrument.

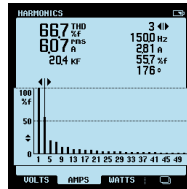

- Voltage, current, and power harmonics
- Up to 51st harmonic
- Total harmonic distortion (THD)
- Phase angle of individual harmonics

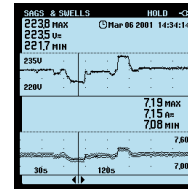

- Continuously measure volts and amps on a cycle-by-cycle basis for up to 16 days
- Use cursors to read time and date of sags and swells

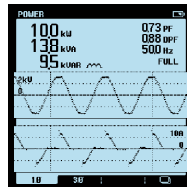

- Watts, power factor, COS ϕ , VA and VAR
- Voltage and current waveforms

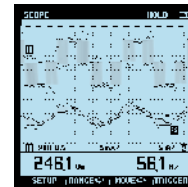

- Connect-and-View™ scope for quick waveform display
- View voltage and current channels simultaneously



On all inputs



True RMS

Specifications

(Check the Fluke web for detailed specifications)

Menu items	Measurements	Ranges	Accuracy
Volts/Amps/Hz	Volts	5,000 V - 1250 V	$\pm(1\%+10)$
	Amps	50.00A - 50.00 kA	$\pm(1\%+10)$
	Mains frequency	40.0 - 70.0 Hz	$\pm(0.5\%+2)$
	CF Crest Factor	1.0 to 10.0	$\pm(5\%+1)$
Power	Watts, VAR, VA	250 W - 1.56 GW	$\pm(4\%+4)$
	PF, DPF, COS ϕ	0.25 W-0.9 0.90-1.00	± 0.04 ± 0.03
Harmonics	Volts	1 st to 51 st harmonic	$\pm(3\%+2)$ to $\pm(15\%+5)$
	Amps	1 st to 51 st	$\pm(3\%+8)$ to $\pm(15\%+5)$
Sags & Swells	Watts	1 st to 51 st	$\pm(5\%+2)$ to $\pm(30\%+5)$
	K-factor	1.0 to 30.0	$\pm 10\%$
Sags & Swells	Voltage and Current	4 min-16 days selectable	$\pm(2\%+10)$
Transient Capture	40 ns pulse width Up to 40 transients	Select 20/50/100/200% above or below line voltage	$\pm 5\%$ of full scale
Inrush Current	1 sec. to 5 min selectable	1 A to 1000 A	$\pm 5\%$ of full scale
Ohms/Continuity/ Capacitance	Ohms	500.0 Ω to 30.00 M Ω	$\pm(0.6\%+5)$
	Capacitance	50.00 nF to 500.0 μ F	$\pm(2\%+10)$
Temperature (with accessory)	$^{\circ}$ C $^{\circ}$ F	-100.0 $^{\circ}$ C to 400.0 $^{\circ}$ C -200.0 $^{\circ}$ F to 800.0 $^{\circ}$ F	$\pm(0.5\%+5)$
Scope	DC, AC, AC+DC, peak, peak-peak, Hz, duty cycle, phase, pulse width, crest factor	Sampling rate:	25 MS/sec
		Bandwidth:	
Screen saves	All functions	Voltage BW (Channel 1)	20 MHz
		Current BW (Channel 2)	15 kHz
Recording	V/A/Hz, Power, Harmonics, Ω /Cap, Temperature, Scope	4 min - 16 days selectable	Select any two parameters display mode in each

Included Accessories

TL224 test lead set, AC220 alligator clip set, TP4 test probe set, BP120MH rechargeable battery pack, BB120 shielded BNC adapter, PM8907 line adapter/charger, i400s AC current clamp, AB200 alligator clip set, TP1-1 test probe set, C120 hand carrying case, OC4USB interface cable, SW43W FlukeView software, VPS 40 voltage probe, Fluke 61 IR thermometer, user and application manual.

Ordering information

Fluke 43B Power Quality Analyzer (single-phase)

Battery life: Rechargeable Ni-MH pack (charger included), 6 hrs typical (continuous)

Shock & Vibration: Mil 28800E, Type 3, Class III, Style B.

Operating temperature: 0 $^{\circ}$ C to 50 $^{\circ}$ C; Case: IP51 (dust, drip, waterproof)

Size (HxWxD): 232 mm x 115 mm x 50 mm; Weight: 1.1 kg

Three Years Warranty

Recommended Accessories



i2000flex
See page 126

i1000s
See page 126

80TK
See page 128

VR1710 Single-Phase Voltage Quality Recorder

FLUKE®



Fluke VR1710



Fluke VR1710 and included accessories



Includes PowerLog software

Easy-to-use solution for detecting and recording voltage quality problems

The Fluke VR1710 is a single-phase, plug-in voltage quality recorder that provides fast and easy recording of voltage trends, dropouts, harmonics and general power quality including dips and surges to help maintenance and facilities management personnel easily pinpoint the root cause of voltage problems. Voltage quality parameters including RMS average, transients, flicker, and harmonics up to the 32nd are recorded using a user-selected average period from 1 second to 20 minutes.

- Clear graphical summary of data and quick overview of key power quality parameters
- Get the complete picture with Min, Max, Average RMS values (1/4 cycle) with time stamps
- See the detailed with actual transient display (> 100 µs) with time stamp
- Comprehensive analysis of Individual harmonic and THD values with trends

Applications

- **Voltage recording** – Monitors and records supply voltage; measures RMS average, minimum and maximum values, and checks whether the socket outlet is providing voltage within tolerance.
- **Distortion measurement** – Measure frequency and harmonics; check whether the distorting loads (UPS systems, drives, etc.) are affecting your other equipment.
- **Flicker measurement** – Quantify the affects of switching loads on lighting systems.
- **Voltage transients** – Capture those intermittent, momentary events that may be affecting your equipment; the full waveform is captured with date, timestamp, and duration.

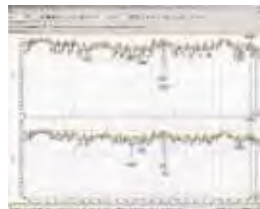

PowerLog Setup – Simple set up of internal clock, logging periods, and intervals with default values for quick results.

PowerLog View – Data presentation showing RMS voltage and harmonic trends, actual transients, summary information and statistics in accordance with EN50160.



Actual transient display (> 100 µs) with time stamp – Quickly identify issues with included graphical software.

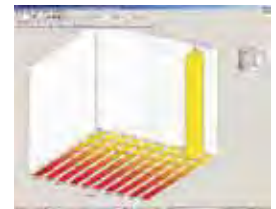

Statistical analysis of voltage event – reduces analysis time by tracking event quantities and magnitudes.

Specifications

(Check the Fluke web for detailed specifications)

Operating voltage	70 V to 300 V
Min/Max/Avg RMS value	Resolution 0.125 V
Number of events	175,000
Dips/Interruptions	Yes
Time resolution	5 ms
Voltage resolution)	0.125 V
Over-voltages	Yes
Frequency	Yes
Harmonics measurement	EN 61000-4-7 (up to 32nd)
Flicker measurement	EN 61000-4-15
Number of recording channels	1 Phase to Neutral 2 Phase/Neutral to Ground
Recording time	1 day to 339 days depending on average time from 1 second to 20 minutes
Transients	Yes (> 100µs)
Frequency range	50 Hz ± 1 Hz and 60 Hz ± 1 Hz
Safety category rating	CAT II 300 V

Included Accessories

Plug-in Fluke VR1710, USB cable, PowerLog software CD, universal power cord adapters.

Ordering Information

Fluke VR1710 Voltage Quality Recorder

Display: LED
Size (HxWxD): 23 x 19.75 x 22.2 cm

Weight: 0.8 kg
Two years warranty

430 Series II Three-Phase Power Quality and Energy Analyzers

FLUKE®

New



Fluke 437-II



Fluke 435-II



Fluke 434-II



On all inputs

True RMS



More detailed power quality analysis capability, and a Fluke-patented energy monetization function

The new Fluke 434, 435 and 437 Series II models help locate, predict, prevent, and troubleshoot power quality problems in three-phase and single-phase power distribution systems. Additionally, the Fluke-patented energy loss algorithm, Unified Power Measurement, measures and quantifies energy losses due to harmonics and unbalance issues, allowing the user to pinpoint the origin of energy waste within a system.

- Energy loss calculator: Classic active and reactive power measurements, unbalance and harmonic power, are quantified to pinpoint true system energy losses in dollars.
- Power inverter efficiency: Simultaneously measure AC output power and DC input power for power electronics systems using optional DC clamp.
- PowerWave data capture: 435 and 437 Series II analyzers capture fast RMS data, show half-cycle and waveforms to characterize electrical system dynamics (generator start-ups, UPS switching etc.).
- Waveform capture: 435 and 437 Series II models capture 100/120 cycles (50/60Hz) of each event that is detected in all modes, without set-up.
- Automatic Transient Mode: 435 and 437 Series II analyzers capture 200 kHz waveform data on all phases simultaneously up to 6 kV.
- Fully Class-A compliant: 435 and 437 Series II analyzer conduct tests according to the stringent international IEC 61000-4-30 Class-A standard with 435 and 437 Series II analyzers.
- 400 Hz measurement: 437 Series II analyzer captures power quality measurements for avionic and military power systems.
- Troubleshoot real-time: Analyze the trends using the cursors and zoom tools.
- Highest safety rating in the industry: 600 V CAT IV/ 1000 V CAT III rated for use at the service entrance.
- Automatic Trending: Every measurement is always automatically recorded, without any set-up.
- System-Monitor: Ten power quality parameters on one screen according to EN50160 power quality standard
- Logger function: Configure for any test condition with memory for up to 600 parameters at user defined intervals.

Unified Power Measurement

Fluke's patented Unified Power Measurement system (UPM) provides the most comprehensive view of power available, measuring:

- Parameters of Classical Power (Steinmetz 1897) and IEEE 1459-2000 Power
- Detailed Loss Analysis
- Unbalance Analysis
- These UPM calculations are used to quantify in dollars the cost of energy loss caused by power quality issues.

Energy savings

The cost of power quality could only be quantified in terms of downtime caused by lost production and damage to electrical equipment. The Unified Power Measurement (UPM) method now goes beyond this to achieve energy savings by discovering the energy waste caused by power quality issues. Using the Unified Power Measurement, Fluke's Energy Loss Calculator will determine how much money as facility is losing due to waste energy.

Unbalance

UPM gives a more comprehensive breakdown of the energy consumed in the plant. In addition to measuring reactive power (caused by poor power factor), UPM also measures the energy waste caused by unbalance; the effect of unevenly loading each phase in three-phase systems.

Harmonics

UPM also provides details of the energy wasted in your facility due to the presence of harmonics. The presence of harmonics in your facility can lead to:

- Overheating transformers and conductors
- Nuisance tripping of circuit breakers
- Early failures of electrical equipment

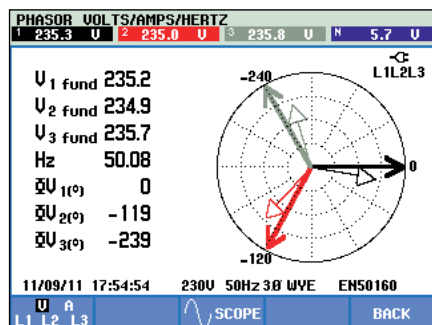

Phasor diagram.

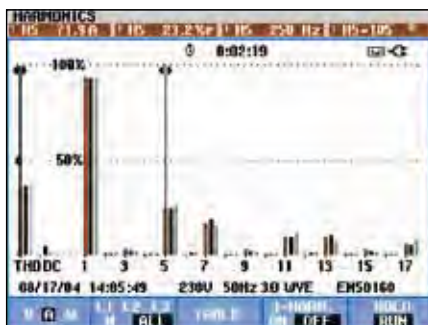

Track harmonics up to the 50th, and measure and record THD in accordance with IEC61000-4-7 requirements.



The System-Monitor overview gives instant insight into whether the voltage, harmonics, flicker, frequency and the number of dips and swells fall outside the set limits. A detailed list is given of all events falling outside the set limits.

430 Series II Three-Phase Power Quality and Energy Analyzers

FLUKE®

Energy Loss Calculator

- Useful kilowatts (power) available
- Kilowatts made unusable by harmonics
- Kilowatts made unusable by unbalance issues
- Total billable kilowatt hours wasted
- Total cost of wasted kilowatt hours

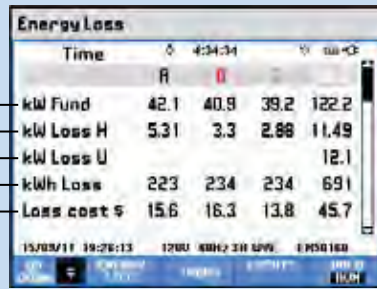

Logging provides instantaneous analysis of user selectable parameters.

Input characteristics

Voltage inputs	
Number of inputs	4 (3 phase + neutral) dc-coupled
Maximum input voltage	1000 Vrms
Nominal voltage range	Selectable 1 V to 1000 V
Max. peak measurement voltage	6 kV (transient mode only)
Input impedance	4 MΩ/5 pF
Bandwidth	> 10 kHz, up to 100 kHz for transient mode
Scaling	1:1, 10:1, 100:1, 1,000:1 10,000:1 and variable
Current inputs	
Number of inputs	4 (3 phase + neutral) dc- or ac-coupled
Type	Clamp or current transformer with mV output or i430flex-TF
Range	0.5 Arms to 600 Arms with included i430flex-TF (with sensitivity 10x) 5 Arms to 6000 Arms with included i430flex-TF (with sensitivity 1x) 0.1 mV/A to 1 V/A and custom for use with optional ac or dc clamps
Input impedance	1 MΩ
Bandwidth	> 10 kHz
Scaling	1:1, 10:1, 100:1, 1,000:1 10,000:1 and variable
Measurement modes	
Scope	4 voltage waveforms, 4 current waveforms, Vrms, Vfund, Arms, A fund, V @ cursor, A @ cursor, phase angles
Volts/amps/hertz	Vrms phase to phase, Vrms phase to neutral, Vpeak, V Crest Factor, Arms Apeak, A Crest Factor, Hz
Dips and swells	Vrms%, Arms%, Pinst with programmable threshold levels for event detection
Harmonics dc, 1 to 50, up to 9th harmonic for 400 Hz	Harmonics Volts, THD, Harmonic Amps, K factor Amps, Harmonic Watts, THd Watts, K factor Watts, Interharmonic Volts, Interharmonic Amps, Vrms, Arms (relative to fundamental or to total rms)
Power and energy	Vrms, Arms, Wfull, Wfund, VAFull, VAFund, VAharmonics, VAunbalance, var, PF, DPF, CosQ, Efficiency factor, Wforward, Wreverse
Energy loss calculator	Wfund, VAharmonics, VAunbalance, var, A, Loss Active, Loss Reactive, Loss Harmonics, Loss Unbalance, Loss Neutral, Loss Cost (based upon user defined cost / kWh)
Inverter efficiency (requires optional dc current clamp)	Wfull, Wfund, Wdc, Efficiency, Vdc, Adc, Vrms, Arms, Hz
Unbalance	Vneg%, Vzzero%, Aneg%, Azero%, Vfund, Afund, V phase angles, A phase angles
Inrush	Inrush current, Inrush duration, Arms%, Vrms%
Monitor	Vrms, Arms, harmonic Volts, THD Volts, PLT, Vrms%, Arms%, Hz, dips, swells, interruptions, rapid voltage changes, unbalance and mains signalling. All parameters are measured simultaneously in accordance with EN50160. Flagging is applied according to IEC61000-4-30 to indicate unreliable readings due to dips or swells
Flicker (435-II and 437-II only)	Pst(1min), Pst, Plt, Pinst, Vrms ½, Arms ½, Hz
Transients (435-II and 437-II only)	Transient waveforms 4x Voltage 4x Amps, triggers: Vrms ½, Arms ½, Pinst
Mains Signaling (435-II and 437-II only)	Relative signaling voltage and absolute signaling voltage averaged over three seconds for up to two selectable signaling frequencies
UPower Wave (435-II and 437-II only)	Vrms%, Arms% W, Hz and scope waveforms for voltage amps and watts
Logger	Custom selection of up to 150 PQ parameters measured simultaneously on 4 phases



Fluke 437 II with all standard accessories.

Included Accessories

TL430 test lead and alligator clip set, i430flex-TF, 61 cm, 4 clamps, BC430 power adapter, BP290 single capacity Li-ion battery, International plug adapter set, WC100 color coding clips and regional decals, 8 GB SD card, PowerLog on CD, USB cable A-Bmini, C1740 softcase (434-II, 435-II), C437 hard case (437-II)

Ordering information

Fluke 434-II Three-Phase Energy Analyzer
 Fluke 435-II Three-Phase Power Quality and Energy Analyzer
 Fluke 437-II Three-Phase Power Quality and Energy Analyzer

Battery life: 7 hours operating time per charge on Li-ion battery pack
Safety: EN61010-1 (2nd edition) pollution degree 2; 1000 V CAT III / 600 V CAT IV
Case: Rugged, shock proof with integrated protective holster, IP51 (drip and dust proof)
Shock: 30 g; **Vibration:** 3g according to MIL-PRF-28800F Class 2
Operating temperature: 0°C to +50°C
Size (HxWxD): 265 mm x 190 mm x 70 mm; **Weight:** 2.1 kg
Three Years Warranty

Recommended Accessories



See page 98 for power quality current clamps

1735 Power Logger



Fluke 1735

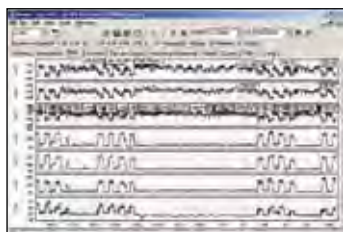

View recorded data in simple graphs and tables with Fluke Power Log software.

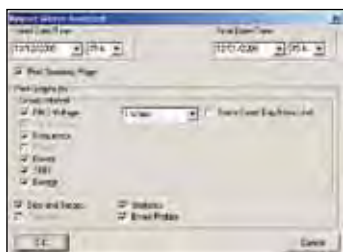

Customize the report generator to easily generate professional looking reports.



Performs electrical load studies, energy consumption testing, and general power quality logging

The Fluke 1735 Power Logger is the ideal tool for electricians and maintenance technicians for conducting energy studies and basic power quality logging. The 1735 is easy to set up with its color display and four included new thinner flexible current probes.

The 1735 logs most electrical power parameters, harmonics and captures voltage events. View graphs and generate reports with the included Fluke Power Log software.

- Record power and associated parameters for up to 45 days
- Monitor maximum power demand over user-defined averaging periods
- Prove the benefit of efficiency improvements with energy consumption tests
- Measure harmonic distortion caused by electronic loads
- Improve reliability by capturing voltage dips and swells from load switching
- Confirm instrument setup easily with color display of waveforms and trends



Conduct load studies for up to 45 days and view saved data on-screen or on a computer.

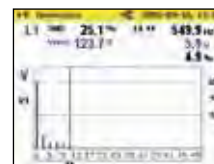

Access voltage and current harmonics up to the 50th.

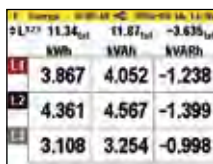

Quantify energy consumption quickly on-screen or log to memory for extended periods.

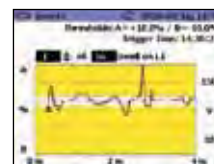

Capture voltage events using user-defined thresholds.

Specifications

(Check the Fluke web for detailed specifications)

Volts rms	V-rms wye measurement ranges: 57 V/66 V/110 V/120 V/127 V/220 V/230 V/240 V/260 V/277 V/347 V/380 V/ 400 V/417 V/480 V AC V-rms delta measurement ranges: 100 V/115 V/190 V/208 V/220 V/380 V/400 V/415 V/450 V/480 V/600 V/660 V/ 690 V/720 V/830 V AC
Amps rms	Flexi set measurement range: 15 A/150 A/3000 A rms (at sine) Current clamp measurement range: 1 A/10 A
Frequency	Measurement range: 46 Hz to 54 Hz and 56 Hz to 64 Hz
Harmonics and THD	To 50th harmonic (< 50 % of nom)
Power measurement (P - Active, S - Apparent, Q - Reactive, D - Distorting)	Measuring range: see V-rms and A-rms measurement ranges
Energy Measurement (kWh, KVAh, kVARh)	Measuring range: see V-rms and A-rms measurement ranges
PF (Power factor)	0.000 to 1.000
Events	Detection of voltage dips, voltage swells and voltage interruptions with a 10 ms resolution and measuring error of the half period sine wave of rms.
General	
Memory	4 MB Flash memory, 3.5 MB for measuring data
Sample rate	10.24 kHz
Line frequency	50 Hz or 60 Hz, user-selectable, with automatic synchronization

Display: VGA Graphic Color transmissive displays 320 x 240 pixels with additional background lighting and adjustable contrast, text and graphics in color
Interface: USB with Mini USB B socket. Firmware updates are possible with the USB interface
Housing: IP65; EN60529 (refers only to the main housing without the battery compartment)

Power supply: NiMH battery-pack, with AC adapter (15 V to 20 V/0.8 A)
Battery Life: Typical > 16 hours without backlight and > 6 hours with backlight high
Operating temperature: 0°C to +40°C
Size (HxWxD): 240 mm x 180 mm x 110 mm
Weight: 1.7 kg, including battery
Two Year Warranty

Included Accessories

FS17X5-TF 4-phase flexible current clamp set, VL1735/1745 voltage lead set, Power Log software, color localization set, PC interface cable, international ac adapter, BC1735 battery charger, soft carrying case, printed English manual and multi-language manual on CD.

Ordering Information

Fluke 1735	Power Logger
FS17X5-TF	4-phase thin flexi current clamp set, 3000 A
3000/6000A-TF-4	4-phase thin flexi current clamp set, 6000 A

Recommended Accessories

See page 98 for power quality current clamps

1740 Series Three-Phase Power Quality Loggers Memobox

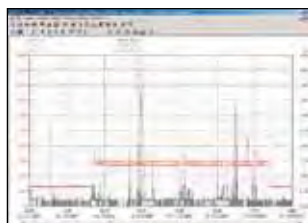

The included PQ Log software helps you to quickly identify the root cause of a disturbance.

Assess power quality and conduct long-term studies with ease

Compact, rugged and reliable, the Fluke 1740 Series three-phase power quality loggers are everyday instruments for technicians who troubleshoot and analyze power distribution systems. Capable of simultaneously logging up to 500 parameters for up to 85 days and capturing events, the Fluke 1740 Series helps uncover intermittent and hard-to-find power quality issues. There are three models to choose from to meet your basic or advanced power logging needs.

Fluke 1743: IP65 waterproof monitor for logging the most common power parameters including V, A, W, VA, VAR, PF, energy, flicker, voltage events and THD.

Fluke 1744: Includes the same features as the Fluke 1743. In addition to common power parameters, the Fluke 1744 also measures voltage and current harmonics, interharmonics, mains signaling, unbalance, and frequency.

Fluke 1745: Advanced IP50 power quality logger with the same measurement capability as the 1744, plus real-time LCD, five hour UPS.

- **Plug and play:** Set up in minutes with automatic current probe detection and powering
- **Installs inside the cabinet:** Compact, fully-insulated housing and accessories fit easily in tight spaces next to live power
- **Monitors power for the long-term:** Data can be downloaded during recording without interruption
- **Measure voltage with premium accuracy:** IEC61000-4-30 Class-A compliant voltage accuracy (0.1%)
- **Quickly validate quality of power:** Assess power quality according to EN50160 power quality standard with statistical overview

Specifications

(Check the Fluke web for detailed specifications)

	1745	1744	1743
Measurement of common power parameters: V, A, W, VA, VAR, PF, energy, flicker, voltage events (dips, swells, interruptions), and THD	●	●	●
Measurement of voltage and current harmonics to the 50th, unbalance, frequency and mains signaling	●	●	
Dust/water resistance	IP 50	IP 65 waterproof	
Display	LED + LCD	LED	LED
Memory	8 MB	8 MB	8 MB
UPS ride-through	> 5 hrs	3s	3s
EN 50160	●	●	●

Included Accessories

Fluke 1743/1744/1745: FS17XX IP65-TF thin flexible current clamp set (1743 & 1744), FS17X5-TF thin flexible current clamp set (1745), VL1735/1745 voltage lead set (1745 only), Power Log software, RS232 interface cable and RS232-USB adapter, 4 black dolphin clips, WC17XX color localization set, carrying bag, test certificate with measurement values, printed English manual and multi-language manual on CD.

Basic models: Excl. current clamps FS17XX-TF

Ordering Information

Fluke 1743 Basic	Power Quality Logger Memobox
Fluke 1743	Power Quality Logger Memobox
Fluke 1744 Basic	Power Quality Logger Memobox
Fluke 1744	Power Quality Logger Memobox
Fluke 1745	Power Quality Logger Memobox
FS17x5-TF	4-phase thin flexi current clamp set, 3000 A
3000/6000A-TF-4	4-phase thin flexi current clamp set, 6000 A

Power supply: 88 V ... 660 V AC
Safety: IEC/EN 61010-1 600 V CAT III, 300 V CAT IV, pollution degree 2, double insulation
Housing: Fully insulated housing and accessories
Operating temperature: 0 °C to 35°C
Interface: RS 232, 9600 ... 115 000 Baud, automatic Baud rate selection, 3-wire communication

Size: Fluke 1745: 282 mm x 216 mm x 74 mm;
 Fluke 1743/44: 170 mm x 125 mm x 55 mm
Weight: Fluke 1745 – approx. 3 kg;
 Fluke 1743/44: approx. 2 kg
Two Year Warranty

See page 98 for power quality current clamps

1750 Three-Phase Power Recorder

FLUKE®



On all inputs

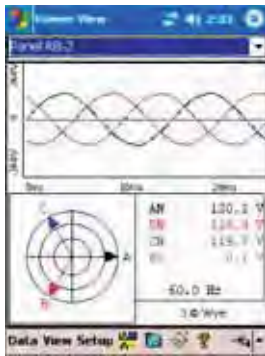

View measurements real time with wireless PDA interface



Included Accessories

PDA and charger power plug adapters, 4 current probes, 5 test leads and clips, SD memory card., Fluke Power View and Fluke Power Analyze software, power cord with international plug set, Ethernet cable, color localization set, soft carrying case, Printed Getting Started manual, CD with software and users manual PDF

Basic model: excl. 4 current probes

Ordering Information

Fluke 1750/B Three-Phase Basic Power Recorder
 Fluke 1750 Three-Phase Power Recorder

Never miss capturing a disturbance

With its exclusive threshold-free measurement system, the Fluke 1750 Power Recorder captures every measurement, every event, on every cycle, all the time. Outstanding accuracy and resolution provide complete visibility into your installation or distribution system.

- Power quality that meets the standard:** All measurements comply with IEC61000-4-30 standards for correct evaluation of all measured values including voltage, current, power, harmonics, flicker etc.
- Quick and reliable configuration:** PDA wireless “front panel interface” provides the ability to verify setup without a laptop along with a window into what the instrument is recording, even in awkward test locations.
- Threshold-free setup:** Apply thresholds after data is collected with Fluke Power Analyzer Software so there is no need to worry about missed information due to incorrect set-up.

- Captures everything:** Cross-channel and current triggering capture every measurement, on every channel, every time.
- Intuitive PC software:** Easily analyze data and generate reports. Automated EN50160 reporting and compliance.
- Plug and play:** Set up in minutes with self-identifying current probes and single-lead voltage connections.
- No need to reconnect wires:** Swap channels internally with the wireless PDA or PC when connections are not correct.
- Measure every parameter:** Voltage and current on three phases, neutral, and ground.
- 5 MHz, 8000 Vpk waveform capture:** Get a detailed picture of even the shortest events.
- Quickly retrieve data:** With included SD memory card or via the 100BaseT high-speed Ethernet connection

Specifications

(Check the Fluke web for detailed specifications)

Power quality measurement standards	
Conformance	IEC 61999-1-4 Class 1, IEC 61000-4-30, IEE519, IEEE1159, IEEE1459 and EN50160
Clock/calendar	Leap years, 24-hour clock
Real-time clock accuracy	Not more than ± 1 s/day
Internal memory capacity for data	At least 1 GB
Maximum recording period	At least 31 days
Measurement time control	Automatic
Maximum number of events	Limited only by the size of the internal memory
Power requirements	100 to 240 V rms ± 10 %, 47-63 Hz, 40 W
Operating time during interruptions (internal UPS operation)	5 minutes per interruption, 60 minutes total operating time without recharging

Safety: EN 61010-1 2nd Edition; 2000
Weight: 6.3 kg
Size (H x W x D): 215 x 310 x 35 mm
One Year Warranty

Recommended Accessories

Model	Description
3210-PR-TF	1000A Thin flexible current transformer 61 cm (24") (20 A - 1000 A)
3310-PR-TF	5000A Thin flexible current transformer 61 cm (24") (100 A - 5000 A)
3312-PR-TF	5000A Thin flexible current transformer 122 cm (48") (100 A - 5000 A)
3140-PR	Clamp-on current transformer (2 A - 400 A)
i40S-PR	Clamp-on current transformer (0.1 A - 40 A)
i4S-PR	Clamp-on current transformer (0,01 A - 5 A)
FLUKE-1750/SEAT-L	Fluke Power Analyze - Additional SEAT LICENSE
FLUKE-1750/SITE-L	Fluke Power Analyze - Additional SITE LICENSE
FLUKE-1750/CASE	Hard Case
CS1750	Soft Case
HP IPAQ 2490	Additional Wireless Interface PDA
FLUKE-1750/MC	Additional 512 MB SD Memory Card

1760 Three-Phase Power Quality Recorder Topas

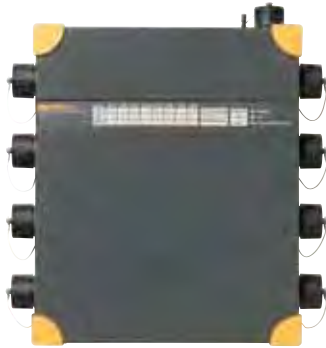

Fluke 1760

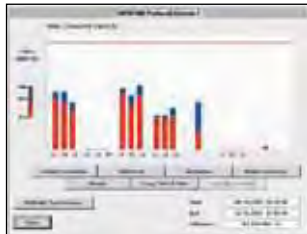

The included PQ Analyze software provides a detailed overview of several power quality parameters on one dashboard according to the EN50160 power quality standard.

Included Accessories

4 x TPS Flex 24-TF flexible current probe, 4 x TPS VoltProbe 600V, 2 GB internal flash memory, ST1760 standard Ethernet cable, RS232 interface cable and RS232-USB adapter, CS1760 crossover Ethernet cable, 1 mains cable, PC software on CD-ROM, WC17xx color localization set, GPS-time sync (1760TR only) CS 1750/1760 carrying bag, hardware and software manual

Basic models: Excl. current clamps TPS Flex 24-TF

Ordering Information

Fluke 1760 Basic Power Quality Recorder Topas
 Fluke 1760TR Basic Power Quality Recorder Topas
 Fluke 1760 Power Quality Recorder Topas
 Fluke 1760TR Power Quality Recorder Topas

Class-A compliance for the most demanding power quality tests

The Fluke 1760 Three-Phase Power Quality Recorder is fully compliant to IEC 61000-4-30 Class-A, for advanced power quality analysis and consistent compliance testing. Designed for analysis of utility and industrial power distribution systems, in medium and low-voltage networks, the Fluke 1760 provides the flexibility to customize thresholds, algorithms, and measurement selections. It has 8 input channels (4 currents/4 voltages or 8 voltages), and captures the most comprehensive details on user selectable parameters.

- **GPS time synchronization:** Correlate data with events or datasets from other instruments with precision
- **Uninterrupted power supply (40 minutes):** Never miss important events - even record the beginning and end of interruptions and outages
- **10 MHz, 6000 Vpk waveform capture:** Get a detailed picture of even the shortest event
- **2 GB data memory:** Enables detailed, simultaneous recording of numerous power parameters for long periods of time
- **Includes Comprehensive software:** Provides trend diagrams for root cause analysis, statistical summaries, report writing and real-time data monitoring in the online mode

Features

(Check the Fluke web for detailed specifications)

	1760 Basic	1760TR Basic	1760	1760TR
Power quality statistics according to EN50160	●	●	●	●
Voltage event list (dips, swells and interruptions)	●	●	●	●
Continuous recording of:				
Voltage	●	●	●	●
Current	●	●	●	●
Power P, Q, S	●	●	●	●
Power factor	●	●	●	●
kWh	●	●	●	●
Flicker	●	●	●	●
Unbalance	●	●	●	●
Frequency	●	●	●	●
Voltage and current harmonics to the 50th/ Interharmonics	●	●	●	●
THD	●	●	●	●
Mains signaling	●	●	●	●
Triggered recordings	●	●	●	●
Online mode (Oscilloscope, transients and events)	●	●	●	●
Fast transient analysis up to 10 MHz		●		●
4 voltage probes			●	●
4 dual-range flexible current probes (1000 A / 200 A ac)			●	●
GPS time sync receiver			●	●
Memory			2 GB Flash memory	

Power supply: 83 V to 264 V, 45 to 65 Hz
Battery pack: NIMH, 7.2 V, 2.7 Ah (up to 40 minutes back-up power supply)
Safety: 600V CAT IV/1000V CAT III (Rated for use at the service entrance)
Housing: Fully insulated robust plastic housing

Operating temperature: 0 °C to 35°C
Interfaces: Ethernet (100 MB/s), RS-232, external modem via RS-232
Size (HxWxD): 325 mm x 300 mm x 65 mm
Weight: Approximately 4.9 kg
Two Year Warranty

Recommended Accessories

(Check the Fluke web for complete accessory list)

Model	Description
• TPS VOLTPROBE 10 V	10 V Voltage Probes (Range: 0.1 V to 17 V)
• TPS VOLTPROBE 100 V	100 V Voltage Probes (Range: 1 V to 170 V)
• TPS VOLTPROBE 400 V	400 V Voltage Probes (Range: 4 V to 680 V)
• TPS VOLTPROBE 600 V	600 V Voltage Probes (Range: 10 V to 1000 V)
• TPS VOLTPROBE 1 KV	1000 V Voltage Probes (Range: 10 V to 1700 V)
• TPS FLEX 18-TF	Flexible Current Probe (Range: 1 A to 100 A / 5 A to 500 A)
• TPS FLEX 24-TF	Flexible Current Probe (Range: 2 A to 200 A / 10 A to 1000 A)
• TPS FLEX 36-TF	Flexible Current Probe (Range: 30 A to 3000 A / 60 A to 6000 A)
• TPS CLAMP 10 A / 1 A	Clip-on Current Transformer (Range: 0.01 A to 1 A / 0.1 A to 10 A)
• TPS CLAMP 50 A / 5 A	Clip-on Current Transformer (Range: 0.05 A to 5 A / 0.5 A to 50 A)
• TPS CLAMP 200 A / 20 A	Clip-on Current Transformer (Range: 0.2 A to 20 A / 2 A to 200 A)
• TPS SHUNT 20 MA	20 mA ac/dc Shunt (Range: 0 to 55 mA)
• TPS SHUNT 5 A	5 A ac/dc Shunt (Range: 0 to 10 A)

Power Quality Current Clamps

Fluke model number	i1A/i10A CLAMP PQ3	i1A/i10A CLAMP PQ4	i5A/i50A CLAMP PQ3	i5A/i50A CLAMP PQ4	i20A/200A CLAMP PQ3	i20A/200A CLAMP PQ4	3000/6000A-TF-4	FS17XS-TF	FS17xx IP65-TF	i3000 flex ...4PK	i400s	i430-FLEXI-TF-4PK	i5sPQ3
Description	3 ... phase 1A/10A Mini current clamp set	4 ... phase 1A/10A Mini current clamp set	3 ... phase 5A/50A Mini current clamp set	4 ... phase 5A/50A Mini current clamp set	3 ... phase 20A/200A Mini current clamp set	4 ... phase 20A/200A Mini current clamp set	4 Phase flexiset IP41	4 Phase flexiset, IP65	4 Phase flexiset, IP65	4 ... phase 3000A Flexible current clamp set	Single phase 400A current clamp (4 required)	4 ... phase 3000A Flexible current clamp set	3 ... phase 5A Current clamp set
Old Fluke model #	CURRENT CLAMPS 1A (EPO450A)	MBX CLAMP 1A/10A+N (EPO451A)	MBX CLAMP 5A/50A (EPO452A)	MBX CLAMP 5A/50A+N (EPO453A)	MBX CLAMP 20/200A (EPO454A)	MBX CLAMP 20/200A+N (EPO456A)	MBX Lem Flex (15/150/3000) (EPO404A)	MBX Lem Flex (15/150/3000) (EPO404A)	MBX Lem Flex (15/150/3000) (EPO404A)				
Fluke 1735	●	●	●	●	●	●	●	●	●				
Fluke 174X	●	●	●	●	●	●	●	●	●				
Fluke 43X													
Nominal current range(s)	1 A 10 A AC	1 A 10 A AC	5 A 50 A AC	5 A 50 A AC	20 A 200 A AC	20 A 200 A AC	30A 300A 3000A 6000A AC	15A 150A 1500A 3000A AC	15A 150A 1500A 3000A AC	30 A 300 A 3000 A	40 A 400 A	3000 A	5 A
Cont. AC current range	10 mA ... 1 A 100 mA ... 10 A	10 mA ... 1 A 100 mA ... 10 A	50 mA ... 5 A 500 mA ... 50 A	50 mA ... 5 A 500 mA ... 50 A	200 mA ... 20 A ... 200 A	200 mA ... 20 A ... 200 A	0.8 ... 6.000 A AC	450mA ... 15A 600mA... 150A 6A... 1500A 12A... 3000A	450mA ... 15A 600mA... 150A 6A... 1500A 12A... 3000A	1 A ... 30 A 1 A ... 300 A 1 A ... 2400 A	0.5 A ... 40 A 5 A ... 400 A	30 A ... 3000 A	0.01 A ... 6 A
Highest current	20 A	20 A	100 A	100 A	300 A	300 A	0.8 A	3300 A	3300 A	4000 A	1000 A	100 kA	70 A
Lowest measurable current	10 mA	10 mA	50 mA	50 mA	200 mA	200 mA		450 mA	450 mA	1 A	0.5 A	30 A	10 mA
Basic accuracy (48 ... 65 Hz) ¹⁾	0.5%	0.5%	0.5%	0.5%	0.5%	0.5%		2%+2% position influence	2%+2% position influence	2% + 2 A	2% + 0.15 A	1%	1%
Usable frequency	40 Hz ... 10 kHz	40 Hz ... 10 kHz	40 Hz ... 10 kHz	40 Hz ... 10 kHz	40 Hz ... 10 kHz	40 Hz ... 10 kHz		40Hz ... 5kHz	40Hz ... 5kHz	10 Hz ... 100 kHz	45 Hz ... 3 kHz	10 Hz ... 7 kHz	40 Hz ... 5 kHz
Requires battery										●			
Flex head length							92 cm	61 cm	61 cm		Clamp opening: 32 mm	61 cm	Clamp opening: 15 mm
Output level(s)	75 mV/A	75 mV/A	15 mV/A	15 mV/A	3.75 mV/A	3.75 mV/A		0.1 mV/A	0.1 mV/A	10 mV/A 1 mV/A 0.1 mV/A	10 mV/A 1 mV/A	0.085 mV/A @50 Hz	400 mV/A
Output cable (m)	2	2	2	2	2	2	4	2	2	2.1	2.5	2.5	2.5
Safety rating	CAT III 600 V	CAT III 600 V	CAT III 600 V	CAT III 600 V	CAT III 600 V	CAT III 600 V	CAT III 1000 V CAT IV 600V	CAT III 1000 V CAT IV 600V	CAT III 1000 V CAT IV 600V	CAT III 600 V	CAT III 1000 V CAT IV 600 V	CAT III 1000 V CAT IV 600 V	CAT III 600 V
Connection	One connector	One connector	One connector	One connector	One connector	One connector	One connector	One connector	One connector	4 x BNC	4 x BNC	4 x BNC	3 x BNC
BNC to banana adapters included	n/a	n/a	n/a	n/a	n/a	n/a	n/a	n/a	n/a	●			

¹⁾ Basic accuracy, % reading plus floorspec.
n/a = not applicable

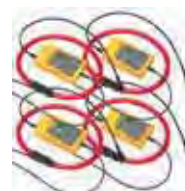

i3000 flex-4PK
(4x i3000s flex24)



i400s



i430-FLEXI-TF-4PK



i5sPQ3

Norma 4000/5000 Power Analyzers

FLUKE®



Fluke Norma Series Power Analyzers



Fluke Norma 4000



Fluke Norma 5000



Reliable, highly accurate measurements for the test & development of power electronics

The compact Fluke Norma Series Power Analyzers provide the latest measurement technology to assist engineers with the development and testing of motors, inverters, lighting, power supplies, transformers and automotive components.

Based on a patented, high-bandwidth architecture, the instruments deliver high-precision measurements of single or three-phase current and voltage, harmonics analysis, Fast Fourier Transformation (FFT) analysis, as well as calculations of power and other derived values.

A unique user-configurable system design with plug-in power phases and other optional modules provides the flexibility to meet a variety of application measurement requirements. Recorded data and waveforms can be viewed clearly in the large color display and easily downloaded to a PC for analysis and report writing.

The Series consists of the Fluke Norma 4000 Three-Phase Power Analyzer and the Fluke Norma 5000 Six-Phase Power Analyzer. These rugged analyzers provide unmatched price performance for easy and reliable use in the field, or as a bench unit in laboratories and on test benches.

- Simple user interface ensures easy, intuitive operation
- Unique user-configurable modular design
- Simultaneous parallel acquisition of all phases
- Voltage, current and power harmonics up to the 40th
- Includes FFT analysis, vector diagram display, recorder function, and Digital Oscilloscope (DSO) mode
- User selectable average time – from 15ms to 3600s
- Expandable on-board memory for storage of measured values

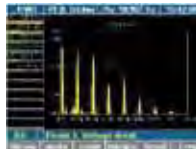

Fast Fourier Transformation (FFT) analysis



Digital Oscilloscope (DSO) mode



Vector Display



Recorder function

Specifications

(Check the Fluke web for detailed specifications)

	Fluke Norma 4000	Fluke Norma 5000
Number of Phases	1 or 3	3, 4 or 6
Weight	Approx. 5 kg	Approx. 7 kg
Size (HxWxD)	15 cm x 23.7 cm x 31.5 cm	15 cm x 44.7 cm x 31.5 cm
On-board Printer	No	Yes (optional)
Display	Color, 5.7" / 144 mm - 320 x 240 pixel	
Bandwidth	dc to 3 MHz or dc to 10MHz depending on input module	
Basic Accuracy	0.2%, 0.1% or 0.03% depending on input modules	
Sampling Rate	0.33 MHz or 1 MHz depending on input modules	
Voltage Input Range	0.3 V to 1000 V	
Current Input Range (direct, not via shunt)	0.03 mA – 20 A depending on input module	
Memory for Configurations	4 MB, expandable to 128 MB	
Memory for Settings	0.5 MB	
Fast Fourier Transformation (FFT)	To the 40th harmonic	
RS232 Interface	Standard	
P11 Process Interface (8 analog/impulse inputs and 4 analog outputs)	Optional	
IEEE 488.2 / GPIB Interface (1 Mbit/s Ethernet / 10 Mbit/s or 100 Mbit/s)	Optional	
Fluke NormaView PC Software (for data download, analysis & report writing)	Standard	

Included Accessories

Power Supply Cable, RS232 Interface and USB adaptor for Data Download, Fluke NormaView PC Software, User's Manual, Test Certificate, and Calibration Values.

Ordering Information

Fluke Norma 4000 Three-Phase High Precision Power Analyzer
 Fluke Norma 5000 Six-Phase High Precision Power Analyzer

Operating temperature:

+ 5 °C to 35 °C

Storage temperature:

- 20 °C to 50 °C

Climatic class: KYG DIN 40040, maximum 85% relative humidity, non-condensing.

Housing:

Solid metal case
Safety: EN 61010-1 / 2nd Edition, 1000 V CAT II (600 V CAT III)

Two Year Warranty

Norma 4000/5000 Power Analyzer Accessories

FLUKE®



Fluke Norma 4000 (rear view)



Fluke Norma 5000 (rear view)

Power Phases

The Fluke Norma 4000 Power Analyzer can be equipped with up to three power phases and the Fluke Norma 5000 Power Analyzer can be equipped with up to six power phases. Users can select the power phase best suited for their application. Specifications vary depending on the model of the power phase.

Each plug-in power phase consists of a voltage and a current measurement channel. Each measuring channel is available for each basic unit.

Power Phase Overview

	3024770	3024812	3024820	3024835
Channel	PP42	PP50	PP54	PP64
Accuracy	0.2% (0.1% rd + 0.1% rg)	0.1% 0.05% rd + 0.05% rg		0.03% (0.02% rg + 0.01% rg)
Current range	20 A	10 A	10 A	10 A
Sampling rate	341 kHz	1 MHz	341 kHz	341 kHz
Bandwidth	3 MHz	10 MHz	3 MHz	3 MHz

Shunts

The input modules can take up to 10 A or 20 A directly or measure current via wideband precision shunts. The available range of shunts enables measurements up to 1500 A and can be used in conjunction with all of the available input modules.



Optional shunts for Fluke Norma Series Power Analyzers

3024677	32 A Planar Shunt
3024689	Cables for 32 A Planar Shunt
3024886	10 A Triaxial Shunt with Cables (0.333 .. 0 to 0.5 MHz)
3024899	30 A Triaxial Shunt with Cables (0.010 .. 0 to 0.5 MHz)
3024847	100 A Shunt with Cables (0.001 Ω, 0 to 0.5 MHz)
3024858	150 A Shunt with Cables (0.5 mΩ, 0 to 0.5 MHz)
3024864	300 A Shunt with Cables (0.1 mΩ, 0 to 1 MHz)
3024873	500 A Shunt with Cables (0.1 mΩ, 0 to 0.2 MHz)
3024692	LG Shunt Cables for High Current Shunts



32 A Planar Shunt

Cables & Adaptors

3024661	Measurement Cable Set (for one power phase)
3024704	Fluke Norma WYE Adaptor (external accessory box)

Printer Accessories

3024650	Printer Cable for Fluke Norma 5000 (RS232-Centronics)
---------	--

All accessories have a two-year warranty.

Field Calibrators

Fluke process calibration tools include a full range of calibrators and troubleshooting tools for instrument technicians working in the process industries. The range of process calibrators include: Documenting Process Calibrators, Multifunction Process Calibrators, single function and multifunction temperature calibrators, a variety of mA loop calibrators and a range of intrinsically safe products.



Field Calibrator Selection Guide

Model	Documenting Process Calibrators			Multifunction Process Calibrator			Temperature Calibrators			Pressure Calibrators			Loop Calibrators					ProcessMeters	
	754	753	755/725Ex	726	724	714	712	718/718Ex	717	719	715	707/707Ex	771	772	773	705	789	787	
Measure	300 V	300 V	30 V	30 V	30 V	75 mV					10 V	28 V			28 V	1000 V	1000 V		
Voltage DC	300 V	300 V	30 V	30 V	30 V	75 mV					28 V				28 V	1000 V	1000 V		
Voltage AC (true RMS)	10 kΩ	10 kΩ	3200 Ω	4000 Ω	3200 Ω		3200 Ω									40 MΩ	40 MΩ		
Resistance	110 mA	110 mA	24 mA	24 mA	24 mA			24 mA	24 mA	24 mA	24 mA	100 mA	100 mA	100 mA	24 mA	30 mA, 1A	30 mA, 1A		
Current DC	50 kHz	50 kHz	10 kHz	15 kHz															
Frequency	● ¹	● ¹	● ¹	● ¹				68.9 mbar to 20 bar / 2 to 7 bar ²	68.9 mbar to 345 bar ²	2 bar to 7 bar ²						●	●		
Pressure	8	8	7	8	7	9	7									20 kHz	20 kHz		
Temperature: RTD types	13	13	12	12	12	9													
Temperature: TC types	Source/Simulate																		
Voltage DC	15 V	15 V	10 V	20 V	10 V	75 mV				10 V									
Resistance	10 kΩ	10 kΩ	3200 Ω	4000 Ω	3200 Ω		3200 Ω												
mA DC/% scale	22 mA	22 mA	24 mA	24 mA	24 mA					24 mA	24 mA	24 mA	24 mA	24 mA	24 mA	24 mA	24 mA		
mA source; auto step; auto ramp	●	●	●	●	●					●	●	●	●	●	●	●	●		
Frequency	50 kHz	50 kHz	10 kHz	15 kHz															
Temperature: RTD types	8	8	7	8	7	9	7												
Temperature: TC types	13	13	10	10	10														
Record																			
Min/Max	●	●						●	●							●	●		
Hold								●	●			●	●	●	●	●	●		
As Found/As Left results	●	●																	
Log data	●	●																	
Upload data to PC	●	●																	
Remote operation			●/-	●															
Features																			
Loop supply	26 V	26 V	24 V/12 V	24 V	24 V			24 V/-	24 V	24 V	24 V	24 V	24 V	24 V	24 V	24 V	24 V		
Hart communication																			
Integrated hand pressure pump								●											
Electric Pump																			
Intrinsically safe (ATEX)			725Ex					718Ex											
NIST traceable certification	●	●	●	●	●	●	●	●	●	●	●	●	●	●	●	●	●		
Warranty in years	3	3	3	3	3	3	3	3	3	3	3	3	3	3	3	3	3		
See catalog page	103	103	104	104	105	106	106	108	108	109	109	110	110	110	109	111	111		

¹ Fluke 700 pressure modules required

² Range for the Fluke 700 series

Ranges for use of Fluke 700 pressure modules, see page 108.

750 Series Documenting Process Calibrators

FLUKE®

New



Fluke 754



Fluke 753



Work smarter. Work faster

Whether you're calibrating instruments, troubleshooting a problem or running routine maintenance, Fluke 750 series process calibrators can help you get the job done faster. It does so many different tasks, so quickly and so well, it's the only process calibrator you need to carry.

- Measure volts, mA, RTDs, thermocouples, frequency, and ohms to test sensors, transmitters and other instruments
- Source/simulate volts, mA, thermocouples, RTDs, frequency, ohms, and pressure to calibrate transmitters
- Power transmitters during test using loop supply with simultaneous mA measurement
- Measure/source pressure using any of 29 Fluke pressure modules
- Measure and source simultaneously with one compact, rugged, reliable tool
- Create and run automated as-found/as-left procedures to satisfy quality programs or regulations. Record and document results
- Advanced features like autostep, custom units, user entered values during test, one-point and two-point switch testing, square root DP flow testing, programmable measurement delay and more
- Control the temperature of selected Hart Scientific Dry Blocks
- Handle fast pulsed RTD transmitters and PLCs in RTD source mode with 1 ms response time
- English, French, German, Italian, and Spanish languages
- Three-year warranty

753: A complete documenting calibrator

The 753 Documenting Process Calibrator automates calibration procedures and captures your data. Use the PC interface for downloading procedures, lists, and instructions to the 753 and for uploading data for printing, archiving and analysis.

754: Get HART-ability

The 754 offers all of the capabilities of the 753, plus integrated HART communication capability. This rugged, reliable tool is ideal for calibrating, maintaining, and troubleshooting HART and other instrumentation.

Instrumentation Management Software

The Fluke 753 and 754 are compatible with Fluke 700SW DPC/TRACK software and with software from Cornerstone, Fisher-Rosemont, Honeywell, Yokogawa, Prime Technologies and On Time Support.

Specifications

(Check the Fluke web for detailed specifications)

Function	Measure	Sourcing
Voltage DC	0.02% + 0.005 mV	0.01% + 0.005 mV
Current DC	0.01% + 5 µA	0.01% + 0.003 mA
Resistance	0.05% reading + 50 mΩ	0.01% output + 10 mΩ
Frequency	0.05 Hz	0.01 Hz
Thermocouples	0.3°C	0.2°C
RTDs	0.07 °C	0.06 °C
Pressure	To 0.05% of full scale. See Pressure Module specifications.	

Operating temperature: -10° C to 50° C

Storage temperature: -20° C to 60° C

Safety: CAT II 300V

Battery Life: Typically over eight hours

Internal Battery Pack: li-ion, 7.2V, 4400 mAh, 30 Wh

Battery Replacement: Via snap-shut door without opening calibrator; no tools required

Weight: 1.2 kg

Size (HxWxD): 245 mm x 136 mm x 63 mm

Three Year Warranty

Included Accessories

Stackable test leads (3 sets), TP220 test probes (3 sets) with extended tooth™ alligator clips (3 sets), AC280 hook clips (2 sets), BP7240 Li-ion battery pack, BC7240 battery charger, C799 field soft case, USB communication cable, getting started guide, instruction manual on CDROM, NIST traceable certificate of calibration, DPCTrack™ 2 sample software that enables upload and printing of calibration records. HART communication cable (754 only).

Ordering Information

Fluke 753	Documenting Process Calibrator
Fluke 754	Documenting Process Calibrator
700 TLK	Process test lead kit
BP7240	753/754 Spare battery
750 SW	DPC/Track2
BC7240	753/754 Battery charger/eliminator
754HCC	754 HART communication cable

Recommended Accessories



C799
See page 130



TL220-1
See page 122



80PK-8
See page 128



80PK-25
See page 128



700P27
See page 112

725/725Ex/726 Multifunction Process Calibrators

FLUKE®



More calibration power!

725/725Ex/726 Multifunction Process Calibrators

- Two separate channels; measure, source and view process signals simultaneously
- Measure volts, mA, RTDs, thermocouples, frequency, and resistance to test sensors and transmitters
- Source/simulate volts, mA, thermocouples, RTDs, frequency, and pressure to calibrate transmitters
- Measure or *source pressure using any of 29 Fluke 700Pxx Pressure Modules
- Source mA with simultaneous pressure measurement to conduct valve and I/P tests
- Perform fast linearity tests with auto step and auto ramp features
- Power transmitters during test using 24 V loop supply and simultaneous mA measurement
- Store frequently-used test setups for later use
- For 725Ex version see also page 118 and 119

*Pressure pump required

726 Precision Multifunction Process Calibrator

- Additional features:
- More precise measurement and calibration source performance, accuracies of 0.01%
 - Transmitter error% calculation
 - Memory storage for up to 8 calibration results
 - Frequency totalizer and frequency pulse train source mode for enhanced flowmeter testing
 - HART mode inserts 250 ohm resistor in mA measure and source for compatibility with HART instrumentation
 - Integrated pressure switch test allows you to capture the set, reset and deadband of a switch
 - Custom RTD curves, add calibration constants for certified RTD probes for enhanced temperature measurement

Features

Simultaneous Function Capability	Channel A	Channel B
24.000 mA DC	M	M or S
24.000 mA DC with 24 V loop supply	M	M or S
100.00 mV DC		M or S
30.000V DC measure	M	M or S
20.000V DC Measure		M or S
10.000V DC Source		M or S
20.000V DC Source		M or S
15 to 3200 Ohms		M or S
5 to 4000 Ohms		M or S
Thermocouple J, K, T, E, R, S, B, M, L, U, N, XK, BP		M or S
RTD Cu 10 , Ni120; Pt100 (392); Pt100 (JIS); Pt100, 200, 500, 1000 (385)		M or S
Pressure (requires Fluke 700 PXX Modules)	M	M used as S
Frequency; 10 kHz; (15 kHz)		M or S

M = Measure S = Source/Simulate
 Unique 726 features are **in bold**
 725Ex: ATEX certified
 (Ex ATEX II IG EEX 1a IIB 171°C)

Included Accessories

Test Leads, AC172 Test Clips, one pair of stackable test leads, user's Manuals on CD-ROM (725Ex also includes CCD control drawing, Statement of Quality Assurance Practices, NIST Traceable calibration certificate)

Ordering Information

Fluke 725 Multifunction Process Calibrator
 Fluke 725Ex Intrinsically Safe Multifunction Process Calibrator
 Fluke 726 Precision Multifunction Process Calibrator

Specifications

Unique 726 features are **in bold**

Function Measure or Source	Range or Type	Resolution	Accuracy	Notes
Voltage	0 to 100 mV 725: 0 to 10V (source) 0 to 20V (source) 725/726: 0 to 30V (measure)	0.01 mV 0.001 V 0.001 V 0.001 V	0.01% 0.02% Rdg + 2 LSD	Max load, 1 mA
mA	0 to 24	0.001 mA	0.01% ; 0.02% Rdg + 2 LSD	Max load, 725/726: 1000Ω 725Ex: 250Ω
mV (TC terminals)	-10.00 mV to +75.00 mV	0.01 mV	0.01% 0.02% of range + 1 LSD	
Ohms	15Ω to 3200Ω 5Ω to 4000Ω	0.01Ω to 0.1Ω	0.10Ω to 1.0Ω 0.015%	
Hz - CPM	2.0 to 1000 CPM 1 to 1100 Hz 1.0 to 10.0 kHz 10.0 to 15.0 kHz	0.1 CPM 1 Hz 0.1 kHz 0.1 kHz	±0.05% ±0.05% ±0.25% ±0.05%	Source; 5V p-p 1V - 20 V p-p squarewave, -0.1 V offset
Loop Supply	725/726: 24 V DC 725Ex: 12 V DC	N/A	10%	
T/C	J, K, T, E, L, N, U, XK	0.1 °C, 0.1 °F	to 0.7 °C to 0.2 °C	
T/C	B, R, S, BP	1 °C, 1 °F	to 1.7 °C to 1.2 °C	
RTDs	Cu (10) , Ni 120 (672) Pt 100, 200, 500, 1000 (385) Pt 100 (3916), Pt 100 (3926)	0.01 °C 0.01 °F	to 0.15 °C	
		0.1 °C, 0.1 °F	to 0.2 °C	

Maximum voltage: 30V
Operating temperature: 10°C to 55°C
Safety: CSA C22.2 No. 1010.1:1992
 EMC: EN50082-1:1992 and EN55022:
 1994 Class B

Size (HxWxD): 200 mm x 96 mm x 47 mm
Weight: 0.65 kg
Battery: Four AA alkaline batteries.
Battery life: 25 hours typical; battery door
Warranty: Three years

Recommended Accessories

(Not for hazardous zones)



C125
See page 130

TL220-1
See page 122

80PK-27
See page 128

TPAK
See page 132

700P27
See page 112

724 Temperature Calibrator



Fluke 724



The temperature solution

The Fluke 724 Temperature Calibrator is a powerful yet easy-to-use calibrator. Use the measure and source functions to test and calibrate almost any temperature instrument.

- Easy to read dual display lets you view input and output simultaneously
- Measure RTDs, thermocouples, ohms, and volts to test sensors and transmitters
- Source/simulate thermocouples, RTDs, volts, and ohms to calibrate transmitters
- Perform fast linearity tests with 25% and 100% steps

- Execute remote tests with auto step and auto ramp
- Power transmitters during test using loop power supply with simultaneous mA measurement
- Store frequently-used test setups for later use

Features

Simultaneous Function Capability	Channel A	Channel B
24.000 mA DC	M	
24.000 mA DC with 24V loop supply	M	
100.00 mV DC		M or S
30.000V DC Measure	M	
20.000V DC Measure 10.000V DC Source		M or S
0 to 3200 Ohms		M or S
Thermocouple J, K, T, E, R, S, B, L, U, N		M or S
RTD Ni120; Pt100 (3926); Pt100 (JIS); Pt100, 200, 500, 1000 (385)		M or S

M = Measure S = Source/Simulate

Specifications

Function Measure or Source	Range	Resolution	Accuracy	Notes
Voltage	0 to 100 mV 0 to 10V (source) 0 to 30V (measure)	0.01 mV 0.01 V 0.001 V	0.02% Rdg + 2 LSD	Max load, 1 mA
mA (measure)	0 to 24 mA	0.001 mA	0.02% Rdg + 2 LSD	Max load, 1000Ω
mV	-10.00 mV to +75.00 mV	0.01 mV	0.025% of range + 1 LSD	
Resistance	0Ω to 3200Ω (measure) 15Ω to 3200Ω (source)	0.01Ω to 0.1Ω	0.10Ω to 1.0Ω	
Loop Supply	24V DC	N/A	10%	
Thermocouples	J, K, T, E, L, N, U	0.1 °C	to 0.7 °C	
Thermocouples	B, R, S	1 °C	to 1.4 °C	
RTDs	Ni120 (672) Pt 100, 200, 500, 1000 (385) Pt 100 (3916) Pt 100 (3926)	0.1 °C	to 0.2 °C	

Maximum voltage: 30V
Operating temperature: -10°C to 55°C
Safety: CSA C22.2 No. 1010.1:1992
 EMC: EN50082-1:1992 and EN55022:1994 Class B

Size (HxWxD): 200 mm x 96 mm x 47 mm
Weight: 0.65 kg
Battery: Four AA alkaline batteries
Battery life: 25 hours typical; battery door
Three Year Warranty

Included Accessories

Test Leads, AC172 Test Clips, one pair of stackable test leads.

Ordering Information

Fluke 724 Temperature Calibrator

Recommended Accessories



C25
See page 130



TL220-1
See page 122



TL81A
See page 121



80PK-25
See page 128



80PK-3A
See page 128

712/714 Temperature Calibrators



Fluke 714



Fluke 712

The clear choice

The Fluke 710 Series Process Calibrators offer clear new choices in single-function calibrators. Whatever you want to measure - temperature, pressure or basic electrical parameters - you'll find one of these easy-to-carry handheld tools gives you exactly the functions you need. They combine the rugged, ready-for-action package of the proven Fluke 80 Series DMMs with the easy-to-use pushbutton operation of the multifunction Fluke 740 Series Documenting Process Calibrators. These calibrators are EMI tolerant, dust and splash resistant, and have a removable battery door for quick battery changes.

712 RTD Calibrator

- Measure temperature from RTD output
- Simulate RTD output
- Rosemount pulsed RTD transmitter compatible
- Operates with seven types of RTDs
- Measure additional RTDs using Ohms measurement function
- Simulate additional RTDs using Ohms source function
- °F or °C selectable
- Four shrouded banana jacks

714 Thermocouple Calibrator

- Measure temperature from TC output
- Simulate TC output
- Operable with nine types of thermocouples
- Calibrate linear TC transmitter with mV source function
- Selectable °F or °C
- Thermocouple mini-jack termination
- Available as accessories; Fluke 700 TC1 and TC2 Thermocouple Mini-plug Kits

Specifications

Model	Function	Range	Resolution	Accuracy	Notes
Fluke 712	Measure/simulate RTD	-200 to 800°C (Pt 100)	0.1°C, 0.1°F	0.33°C, 0.6°F (Pt 100)	Pt; 100, 200, 500, 1000 (385); Pt 100 (3926); Pt 100 (3916) JIS; Ni 120 (672)
	Measure/simulate Resistance	15 Ω to 3200 Ω	0.1 Ω	0.1 Ω to 1 Ω	
Fluke 714	Measure/simulate Thermocouple	-200 to 1800°C, depending on type (K, -200 to 1370°C)	0.1-C or °F (1°C or °F; BRS)	0.3°C to 10 μV	9 TC types: J K T E R S B per NIST 175 and ITS-90, L U per DIN 43710 and IPTS-68
	Measure/simulate mV	-10 to 75 mV	0.01 mV	0.025% + 1 count	



Included Accessories

Yellow Holster (H80M excl. TPAK), Test Leads and AC172 Alligator Clips (excluding model 714), single 9V alkaline battery and Instruction Sheet (14 languages)

Ordering Information

Fluke 712 RTD Calibrator
 Fluke 714 Thermocouple Calibrator

Maximum voltage: 30 V
Operating temperature: -10°C to 55°C
Safety: CSA C22.2 No. 1010.1:1992
 EMC: EN50082-1:1992 and EN55022:1994 Class B

Size (HxWxD): 201mm x 98 mm x 52 mm
Weight: 0.6kg
Battery: 9V alkaline
Battery Life: 4 to 20 hours, typical, depending on functions used
Three Year Warranty

Recommended Accessories



C25
See page 120



C50
See page 120



TL970
See page 121



TL220-1 (714)
See page 122



80PK-24 (714)
See page 128

9140 Series Field Metrology Wells 4180 Series Infrared Calibrators

FLUKE®



Fluke 9142/9143/9144



Fluke 4180/4181

Field Metrology Wells and infrared calibration targets

9142, 9143, 9144

Field temperature calibration with precision and speed

The Fluke 9140 series Field Metrology Wells extend high performance portable temperature calibration to the industrial process environment by maximizing portability, speed, and functionality with little compromise to metrology performance.

Offering a broad temperature covered by three models you can easily cover varied contact temperature probe workloads between -25 °C to 660 °C.

They are quick to reach temperature set points, yet they are stable, uniform, and accurate. These industrial temperature calibrators are perfect for performing transmitter loop calibrations, comparison calibrations, or simple checks of thermocouple sensors.

Adding the process option means there is no need to carry additional tools into the field. The optional built-in two-channel readout measures resistance, voltage, and 4-20 mA current with 24V loop power.

- Lightweight, portable, and fast
- Cool to -25 °C in 15 minutes and heat to 660 °C in 15 minutes
- Built-in two-channel readout for PRT, RTD, thermocouple, 4-20 mA current
- On-board automation and documentation
- Metrology performance in accuracy, stability, uniformity, and loading

4180/4181 IR Calibrators

True metrology solution for infrared Calibration

Now it's easy to increase your IR temperature measurement accuracy in the lab or the field with the new 4180/81 Precision Infrared Calibrators from Fluke's Hart Scientific division.

Their accredited calibrations from Hart's IR laboratory help to ensure traceable, consistent measurements accurate to +0.25 °C. Select from eight preconfigured Fluke thermometer settings or set up your own.

The large 152 mm (6 inch) target helps eliminate errors. So whether you're measuring from -15 °C to 120 °C (4180) or from 35 °C to 500 °C (4181) you'll get a 4:1 TUR.

- High performance, designed for industrial use
- Guaranteed accuracy specifications
- Excellent stability and uniformity
- Large 152 mm targets capture peripheral vision of IR thermometer
- Portability and speed for field use - including convenient bail handle
- Simulates individual IR thermometer emissivity settings
- No difficult infrared calculations
- Fluke and Raytek thermometer calibration points can be loaded directly into the calibrator for convenience
- Calibrated in accredited infrared laboratory by Hart Scientific, the experts in temperature calibration
- At least 4 times more accurate than most IR thermometers
- Calibration includes uncertainties from surface heat loss and emissivity

Included Accessories

914x: 9930 Interface-it Software, Report of Calibration, Test leads (P Version Only), 6-pin DIN Connector for Reference Probe (P Version Only)

Ordering Information

Fluke 4180	Precision Infrared Calibrator, -15 °C to 120 °C
Fluke 4181	Precision Infrared Calibrator, 35 °C to 500 °C
Fluke 4180-CASE	Carrying Case, 4180, 4181
Fluke 4180-DCAS	Carrying Case with wheels, 4180, 4181
Fluke 9142-X	Field Metrology Well, Low Temp
Fluke 9143-X	Field Metrology Well, Mid Temp
Fluke 9144-X	Field Metrology Well, High Temp

Add -P to order optional Process option (914X-X-P). X represents insert type, A, B, C, D, E or F

Specifications

	9142	9143	9144	4180	4181
Temp Range	-25 °C to 150 °C	33 °C to 350 °C	50 °C to 660 °C	-15 °C to 120 °C	35 °C to 500 °C
Stability	±0.01 °C Full Range	±0.02 °C at 33 °C ±0.02 °C at 200 °C ±0.03 °C at 350 °C	±0.03 °C at 50 °C ±0.04 °C at 420 °C ±0.05 °C at 660 °C	±0.05 °C at 0 °C	±0.2 °C at 250 °C
Uniformity	±0.01 °C Full Range	±0.01 °C at 33 °C ±0.015 °C at 200 °C ±0.02 °C at 350 °C	±0.02 °C at 50 °C ±0.05 °C at 420 °C ±0.15 °C at 660 °C	±0.1 °C at 0 °C	±0.1 °C at 35 °C
Target Size diameter	N/A	N/A	N/A	152.4 mm diameter	152.4 mm
Emissivity Range	N/A	N/A	N/A	Preset to 0.95	Preset to 0.95
NIST Accredited Calibration	YES	YES	YES	YES	YES

9142/9143/9144:

Size (HxWxD): 290 x 185 x 295 mm
Weight: 9142: 8.2 kg, 9143: 7.3 kg, 9144: 7.7 kg
One Year Warranty

4180/4181

Size (HxWxD): 241 x 356 x 241 mm
Weight: 4180: 9.1 kg, 4181: 9.5 kg
One Year Warranty

For the complete line of Fluke heat sources check the Fluke website

717/718/718Ex/719 Pressure Calibrators

FLUKE®



Fluke 719



Fluke 717



Fluke 718Ex



Fluke 718



Pump up the pressure

717 Pressure Calibrators

- Measure pressure, 0.025% of full scale with internal sensor
 - 1/8 NPT pressure fitting
 - Compatible with non-corrosive gasses and liquids
- Pressure measurement to 690 bar
- Wide range of selectable measurement units for pressure
- Current measurement with 0.015% accuracy and 0.001mA resolution
- Simultaneous pressure and current measurement for easy P/I testing
- 24 volt loop power supply
- Zero, Min-Max, Hold and Damping functions
- Pressure switch test captures set, reset and deadband values

718 Pressure Calibrators

Same features as Fluke 717 plus:

- Newly designed built-in pressure/vacuum hand pump with vernier and bleed valve helps protect the pump from damage and is easier to clean

For 718Ex Intrinsically Safe Pressure Calibrator see chapter on Ex products in this catalog.

719 Electric Pressure Calibrator

Same features as Fluke 717 plus:

- Electric pump for one handed operation
- mA source for calibrating I/P devices and 4-20 mA I/O
- Best in class pressure measurement accuracy of 0.025%
- Programmable pump limit settings can eliminate overpressurization - set 'pump to' pressure values

Specifications

Model	Range	Resolution	Over Pressure
719 30G	-850 mbar to 2 bar	0.1 mbar	Over pressure 2xFS
719 100G	-850 mbar to 7 bar	1 mbar	Over Pressure 2xFS
718 1G	-68.9 mbar to 68.9 mbar	0.001 mbar	Over Pressure 5xFS
718 30G	-850 mbar to 2 bar	0.1 mbar	Over Pressure 2xFS
718 100G	-850 mbar to 7 bar	0.1 mbar	Over Pressure 2xFS
718 300G	-850 mbar to 20 bar	1 mbar	Over Pressure 375 PSI, 25 bar
717 1G	-68.9 mbar to 68.9 mbar	0.001 mbar	Over Pressure 5xFS
717 15G	-830 mbar to 1 bar	0.01 mbar	Over Pressure 2xFS
717 30G	-850 mbar to 2 bar	0.1 mbar	Over Pressure 2xFS
717 100G	-850 mbar to 7 bar	0.1 mbar	Over Pressure 2xFS
717 300G	-850 mbar to 20 bar	1 mbar	Over Pressure 375 PSI, 25 bar
717 500G	0 mbar to 34.5 bar	1 mbar	Over Pressure 2xFS
717 1000G	0 mbar to 69 bar	1 mbar	Over Pressure 2xFS
717 1500G	0 bar to 103.4 bar	0.01 bar	Over Pressure 2xFS
717 3000G	0 bar to 207 bar	0.01 bar	Over Pressure 2xFS
717 5000G	0 bar to 345 bar	0.01 bar	Over Pressure 2xFS
717 10000G	0 bar to 690 bar	0.01 bar	Over Pressure 2xFS

For Fluke 717/718/719 models: Supported Pressure Units; psi, in. H₂O(4°C), in. H₂O(20°C), cm H₂O(4°C), cm H₂O(20°C), bar mBar, kPa, inHg, mmHg, kg/cm²

Functions: Zero, Min, Max, Hold, Damp functions

Max. Voltage: 30 V

Operating temperature: -10°C to 55°C

Safety: CSA C22.2 No. 1010.1:1992

EMC: EN50082-1:1992 and EN55022:1994 Class B

Fluke 717: For use with non corrosive gasses and liquids

Fluke 718/719: For use with Dry Air only

717

Size (HxWxD): 201 mm x 98 mm x 52 mm

Weight: 0.6 kg

Three years Warranty

718/718Ex

Size (HxWxD): 216 mm x 94 mm x 66 mm

Weight: 0.992 kg

Warranty: Three years (Pump one year)

719

Size (HxWxD): 210 mm x 87 mm x 60 mm

Weight: 0.912 kg

Three Year Warranty (Pump one year)

Included Accessories

Fluke 717, 718, 718Ex and 719:

Yellow Holster (718Ex red holster), Test leads, AC172 Alligator Clips, Single 9V alkaline battery (two 9V batteries in 718 and 719), User manual on CD ROM.

719 also includes: Push fit connectors, Translucent test hose.

Ordering Information

Fluke 719 30G	Electric Pressure Calibrator
Fluke 719 100G	Electric Pressure Calibrator
Fluke 718 1G	Pressure Calibrator
Fluke 718 30G	Pressure Calibrator
Fluke 718 100G	Pressure Calibrator
Fluke 718 300G	Pressure Calibrator
Fluke 718Ex 30G	Intrinsically Safe Pressure Calibrator
Fluke 718Ex 100G	Intrinsically Safe Pressure Calibrator
Fluke 717 1G	Pressure Calibrator
Fluke 717 15G	Pressure Calibrator
Fluke 717 30G	Pressure Calibrator
Fluke 717 100G	Pressure Calibrator
Fluke 717 300G	Pressure Calibrator
Fluke 717 500G	Pressure Calibrator
Fluke 717 1000G	Pressure Calibrator
Fluke 717 1500G	Pressure Calibrator
Fluke 717 3000G	Pressure Calibrator
Fluke 717 5000G	Pressure Calibrator
Fluke 717 10000G	Pressure Calibrator

Recommended Accessories

(Not for hazardous zones)



C43 (718)
See page 130



C125 (717)
See page 130



TL220-1
See page 122



700P27
See page 112



700 LTP-1
See page 112

705/707/707Ex/715 Loop Calibrators

FLUKE®



Fluke 705



Fluke 715



Fluke 707



Fluke 707Ex



4-20 mA, source, measure, simulate

705 Loop Calibrator

- Simultaneous mA and %
- mA accuracy of 0.02%
- Measure, source and simulate mA
- Push button 25% steps for fast, easy linearity checks
- “Span Check” for fast confirmation of zero and span
- Selectable slow ramp, fast ramp, and step function
- 24 volt internal loop supply
- 0 - 20 mA or 4 - 20 mA default start up modes

707 Loop Calibrator

- Features of the Fluke 705
- “Quick Click” detented rotary knob for one handed operation
- Higher accuracy: 0.015%
- Mains Voltage Input protection
- 250 Ohm loop resistance for with Hart instrumentation

715 Volt/mA Calibrator

- Measure loop current (0-20 mA, 4-20 mA) signals with 0.015% accuracy and 0.001 mA resolution
- Measure voltage output process signals from PLCs, transmitters
- Source or simulate 24 mA loop current
- Source voltage to 100 mV or 10 V
- 24 V loop supply with simultaneous current measurement

707Ex Intrinsic Safe Loop Calibrator

- Same features as Fluke 707
- For use in explosion endangered areas
- ATEX certified (II 2 G Eex ia IIC T4)

Specifications

Functions	705/707/707 Ex	715
Voltage measurement		
Range	0-28 V DC	0-200 mV, 0-20 V
Resolution	1 mV	10 μ V 1 mV
Accuracy	705: 0.025% Rdg + 2 LSD 707/707Ex: 0.015% Rdg + 2 LSD	0.01% Rdg + 2 LSD
Current measurement		
Range	0-24 mA	0-24 mA
Resolution	0.001 mA	0.001 mA
Accuracy	705: 0.025% Rdg + 2 LSD 707/707Ex: 0.015% Rdg + 2 LSD	0.015%
Current sourcing		
Range	0-20 mA or 4-20 mA ¹	0-20 mA or 4-20 mA ¹
Accuracy	705: 0.025% Rdg + 2 LSD 707/707Ex: 0.015% Rdg + 2 LSD	0.015% + 2 LSD
Drive capability	705: 1000 Ω @ 24 mA 707: 1200 Ω @ 24 mA 707Ex: 700 Ω @ 20 mA	1000 Ω @ 24 mA
Loop power while measuring mA	24 V	24 V
Voltage sourcing	N/A	0-100 mV or 0-10 V
Display current and % of span	Yes	mA or %
Auto step, auto ramp	Yes	Yes
Span Check	Yes	Yes

¹ will over-range to 24 mA

Included Accessories

Fluke 705/707: C10 Yellow Holster, Test Leads, AC172 Alligator Clips, Single 9V alkaline battery, Instruction Sheet

Fluke 707Ex: Red Ex-holster, Test Leads, AC172 Alligator Clips, Single 9V alkaline battery, Instruction Sheet

Fluke 715: Yellow Holster (H80M excl. TPAK), Test Leads and AC172 Alligator Clips, Single 9V alkaline battery, Instruction Sheet

Ordering Information

Fluke 705 Loop Calibrator
 Fluke 707 Loop Calibrator
 Fluke 707Ex Intrinsic Safe Loop Calibrator
 Fluke 715 Volt/mA Calibrator

Fluke 705, 707, 707Ex

Maximum voltage: 30 V (28 V - 707Ex)

Operating temperature: -10 to 55°C

Safety: CSA C22.2 No. 1010.1: 1992

EMC: EN50082-1:1992 and EN55022: 1994 Class B

Size (HxWxD): 164 mm x 75 mm x 47 mm;

Weight: 0.35 kg

Battery: One 9 V alkaline

Battery life: 18 hours typical, at 12 mA

Three Year Warranty

715

Size (HxWxD): 201 mm x 98 mm x 52 mm

Weight: 0.6 kg

Battery: One 9V alkaline

Battery life: 4 to 20 hours

Three Year Warranty



C12A (705/707)
See page 130



C25 (715)
See page 130



TL220-1
See page 122



TP920
See page 121



T PAK (715)
See page 132

771, 772 and 773 mA Process Clamp Meters

FLUKE®



Fluke 771



Fluke 772



Fluke 773

mA measurements without breaking the loop. Save time. Save money.

Fluke 771, 772 and 773

- Measure 4 to 20 mA signals without "breaking the Loop," save time and money troubleshooting 4 to 20 mA signals

Fluke 772 and 773

- Source 4 to 20 mA signals for testing control system I/O or I/Ps
- Simulate 4 to 20 mA signals for testing control system I/O
- Measure 4 to 20 mA signals with in-circuit measurement
- Power a transmitter with the 24 V loop power supply
- Automatically ramp and step change the 4 to 20 mA output for remote testing

Fluke 773

- DC voltage measurement to verify 24 V power supplies or voltage I/O signals
- Source dc voltage to test voltage input devices
- Scaled mA output signal enables a logging DMM (289) to record 4 to 20 mA signal without breaking the loop
- mA in/out: simultaneously source a mA signal while measuring a mA signal with the clamp

Features

	771	772	773
mA measure w/jaw	●	●	●
mA measure in circuit		●	●
mA source		●	●
mA sim		●	●
Loop power 24 V		●	●
DCV source 0-10 V			●
DCV measure 0-30 V			●
Scaled mA output to mA input			●
mA in/out			●

Specifications

	Function	Resolution and range	Accuracy	Notes
771, 772, 773	mA measurement	0 to 20.99 mA 21.0 mA to 100.0 mA	0.2 % + 5 counts 1 % + 5 counts	Measured by clamp
772 and 773	mA measurement	0 to 24.00 mA	0.2 % + 2 counts	Measured in series with test jacks
772 and 773	mA source	0 to 24.00 mA	0.2 % + 2 counts	Maximum mA drive: 24 mA into 1,000 ohms
772 and 773	mA simulate	0 to 24.00 mA	0.2 % + 2 counts	Maximum voltage 50 V dc
773	Voltage source	0 to 10.00 V dc	0.2 % + 2 counts	2 mA maximum drive current
773	Voltage measure	0 to 30.00 V dc	0.2 % + 2 counts	

Included Accessories

Fluke 771: soft carrying case and user's manual
Fluke 771 + 772: plus test leads, AC172 alligator clip set and TL940 mini-hook test lead set

Ordering Information

Fluke 771 Milliamp Process Clamp Meter
Fluke 772 Milliamp Process Clamp Meter
Fluke 773 Milliamp Process Clamp Meter

Size (HxWxD):

771: 212 mm x 59 mm x 38 mm
772 + 773: 248 mm x 76 mm x 41 mm

Weight: 771: 0.26 kg

772 + 773: 0.42 kg

Battery: 771: 2x 1.5V Alkaline, IEC LR6

772 + 773: 4x 1.5V Alkaline, IEC LR6

Battery Life: 771: 20 hours typical

772 + 773: 12 hours @ 12 mA source into 500 ohms

IP Rating: IP 40

Warranty: 3 years, 1 year on mA clamp accessory and cable

787/789 ProcessMeters



Fluke 787



Fluke 789



Double your power

The Fluke 787 and 789 ProcessMeters combine a Digital Multimeter and a Loop Calibrator in one rugged handheld tool, giving process technicians double the power.

The Fluke 789 has a built-in 24 V loop supply which reduces the need for taking a separate power supply when doing offline transmitter testing. The IR communication port of the Fluke 789 allows data to be logged to optional

FlukeView Software for graphical analysis and reporting.

Features

	787	789
DMM and Loop Calibrator in one tool	●	●
Precision 1000 V, 440 mA True RMS Digital Multimeter	●	●
DC current source and Loop Calibrator	●	●
24 V Loop power supply		●
Min/Max / Average / Hold / Relative Modes	●	●
Diode Test and Continuity Beeper	●	●
Manual Step (100%, 25%, Coarse, Fine) plus Auto Step and Auto Ramp	●	●
Simultaneous mA and % of scale read-out	●	●
Externally accessible battery / fuses	●/-	●/●
HART mode setting with loop power and a built-in 250 Ω resistor		●
0% and 100% buttons to toggle between 4 and 20 mA sourcing for a quick span check		●
Infrared I/O serial port		●

Specifications

	787	789
Voltage measurements		
Range	0-1000 V AC or DC	0-1000 V AC or DC
Resolution	0.1 mV to 1.0 V	0.1 mV to 1.0 V
Accuracy	0.1% Rdg+1 LSD (V DC)	0.1% Rdg+1 LSD (V DC)
Current measurement		
Range	0-1 A 0-30 mA	0-1 A 0-30 mA
Resolution	1 mA 0.001 mA	1 mA 0.001 mA
Accuracy	0.2%+2 LSD 0.05%+2 LSD	0.2%+2 LSD 0.05%+2 LSD
Current Sourcing		
Range	0-20 mA or 4-24 mA	0-20 mA or 4-24 mA
Accuracy	0.05% of span	0.05% of span
Other specifications		
Max drive capability	500 Ω	1200 Ω
Loop power	N/A	24 V
Resistance measurement	To 40 MΩ, 0.2%+1 LSD	To 40 MΩ, 0.2%+1 LSD
Frequency	To 19.999 kHz, 0.005%+1 LSD	To 19.999 kHz, 0.005%+ LSD
Continuity	Beeps for resistance < 100 Ω	Beeps for resistance < 100 Ω
Span Check	No	Yes

Included Accessories

787: Yellow Holster (H80M excl. TPAK), Hard Point Test Lead Set plus AC172 Alligator Clips, one 9V battery, user manual
 789: Test Lead Set plus AC172 Alligator Clips, four 9V AA alkaline batteries, user manual and quick reference guide.

Ordering Information

Fluke 787 ProcessMeter
 Fluke 789 ProcessMeter
 FVF-SC2 FlukeView Forms Software including interface cable

Maximum voltage: 1000 V
Operating temperature: -20 to 55°C

787
Size (HxWxD): 201 mm x 98 mm x 52 mm
Weight: 0.642 kg
Battery: One 9 V alkaline
Battery life: 12 to 50 hours typical
Three Year Warranty

789
Size (HxWxD): 203 mm x 100 mm x 50 mm
Weight: 0.6 kg
Battery: Four AA alkaline batteries
Battery life: 14 to 140 hours typical
Three Year Warranty

Recommended Accessories



C125
See page 130



TL220-1
See page 122



80T-150U
See page 128



i400
See page 126



i410
See page 127

Field Calibrator Accessories



Fluke 700 Series Pressure Modules

- Ranges from 2.5 mbar to 700 bar.
- Gage, differential, dual (compound), absolute and vacuum modules
- Very high accuracy: up to 0.025% FS
- Features internal temperature compensation from 0°C to 50°C for full-accuracy performance
- Pressure readings update twice per second, and may be displayed in any of 11 different units
- Compatible with Fluke 717, 718, 725 and 75x series.
- Rugged cases protect the modules from harsh environments
- All modules include NIST traceable certificate and test data
- ATEX certified Ex versions available (Ex II 1 Eex ia IIB T4)

Model		Range (approx.)	Resolution uncertainty (23 ± 3°C) (FS)	Reference	High side media	Low side media	Fitting material	Max overpressure ²⁾
Differential								
700P00		2.5 mbar	0.001 mbar	0.3 %	Dry ¹⁾	Dry ¹⁾	316 SS	30x
700P01/700P01Ex	Ex	25 mbar	0.01 mbar	0.2 %	Dry	Dry	316 SS	3x
700P02		70 mbar	0.007 mbar	0.15 %	Dry	Dry	316 SS	3x
700P22		70 mbar	0.007 mbar	0.1 %	316 SS	Dry	316 SS	3x
700P03		340 mbar	0.01 mbar	0.05 %	Dry	Dry	316 SS	3x
700P23		340 mbar	0.01 mbar	0.025 %	316 SS	Dry	316 SS	3x
700P04		1000 mbar	0.1 mbar	0.025 %	Dry	Dry	316 SS	3x
700P24/700P24Ex	Ex	1001 mbar	0.1 mbar	0.025 %	316 SS	Dry	316 SS	3x
Gage								
700P05/700P05Ex	Ex	2 bar	0.1 mbar	0.025 %	316 SS	N/A	316 SS	3x
700P06/700P06Ex	Ex	7 bar	0.7 mbar	0.025 %	316 SS	N/A	316 SS	3x
700P27/700P27Ex	Ex	20 bar	1 mbar	0.025 %	316 SS	N/A	316 SS	3x
700P07		34 bar	1 mbar	0.025 %	316 SS	N/A	316 SS	3x
700P08		70 bar	7 mbar	0.025 %	316 SS	N/A	316 SS	3x
700P09/700P09Ex	Ex	100 bar	10 mbar	0.025 %	316 SS	N/A	316 SS	2x
Absolute								
700PA3		340 mbar	0.01 mbar	0.05 %	316 SS	N/A	316 SS	3x
700PA4/700PA4Ex	Ex	1000 mbar	0.1 mbar	0.05 %	316 SS	N/A	316 SS	3x
700PA5		2 bar	0.1 mbar	0.05 %	316 SS	N/A	316 SS	3x
700PA6		7 bar	0.7 mbar	0.05 %	316 SS	N/A	316 SS	3x
Vacuum								
700PV3		-340 mbar	0.01 mbar	0.04 %	316 SS	Dry	316 SS	3x
700PV4		-1000 mbar	0.1 mbar	0.04 %	316 SS	Dry	316 SS	3x
Dual								
700PD2		± 70 mbar	0.007 mbar	0.15 %	316 SS	Dry	316 SS	3x
700PD3		± 340 mbar	0.01 mbar	0.04 %	316 SS	Dry	316 SS	3x
700PD4		±1000 mbar	0.1 mbar	0.025 %	316 SS	Dry	316 SS	3x
700PD5		-1000/+2000 mbar	0.1 mbar	0.025 %	316 SS	N/A	316 SS	3x
700PD6		-1000 mbar/+6.9 bar	1 mbar	0.025 %	316 SS	N/A	316 SS	3x
700PD7		-1000 mbar/+13.8 bar	1 mbar	0.04 %	316 SS	N/A	316 SS	3x
High								
700P29/700P29Ex	Ex	200 bar	0.01 bar	0.05 %	C276	N/A	C276	2x
700P30		340 bar	0.05 %	0.05 %	C276	N/A	C276	2x
700P31		700 bar	0.07 bar	0.05 %	C276	N/A	C276	1.5x

¹⁾"Dry" indicates dry air or non-corrosive gas as compatible media. "316 S S" indicates media compatible with Type 316 Stainless Steel. "C276" indicates media compatible with Hastelloy C276.
²⁾Maximum overpressure specification includes common mode pressure.

Other accessories



Fluke 700HTP-2



Fluke 700LTP-1



Fluke 700PTP-1

700LTP-1 Low-pressure Test Pump

- For low pressure applications
- Vacuum to -13 psi / -.90 bar
- Pressure to 100 psi / 6.9 bar
- With fine-control, adjustable relief valve and slow bleed capability

700PTP-1 Pneumatic Test Pump-1

- Handheld pressure pump
- Pressures up to 600 psi, 40 bar

700HTP-2 Hydraulic Test Pump

- Pressures up to 10,000 psi/690 bar.

700PRV-1 Pressure Relief Valve

- Pressure relief valve for 700HTP-1
- Adjustable from 725 to 5800 PSI (50 to 200 bar)

700HTH-1 Hydraulic Test Hose

- Hydraulic test hose is a 10,000 psi, 690 bar

700ILF In-Line Filter for the Fluke 718

700PCK Pressure Module Calibration Kit

BE9005 Battery Eliminator

Vibration Tester

With the Fluke 810 Vibration Tester you will be able to control unplanned downtime, prevent recurring problems, set repair priorities and manage your resources with an entirely new approach to vibration testing. In three quick, easy steps, the new Fluke 810 helps you locate and diagnose common mechanical problems and prioritize their repair actions. The combination of powerful algorithms and a database of real-world measurement experience make the Fluke 810 the most advanced troubleshooting tool for mechanical maintenance teams who need an answer now.



810 Vibration Tester



Fluke 810

Set-up



Measure



Diagnose



Language support:
eng, ger, fre, ita, spa, por

Motor diagnosis and repair in three simple steps

The Fluke 810 Vibration Tester is the most advanced troubleshooting tool for mechanical maintenance teams who need an answer now. The unique diagnostic technology helps you quickly identify and prioritize mechanical problems, putting the expertise of a vibration analyst in your hands.

Use the vibration tester to:

- Troubleshoot problem equipment and understand the root cause of failure
- Survey equipment before and after planned maintenance and confirm the repair
- Commission new equipment and ensure proper installation
- Provide quantifiable proof of equipment condition and drive investment in repair or replacement
- Prioritize and plan repair activities and operate more efficiently
- Anticipate equipment failures before they happen and take control of spare parts inventories
- Train new or less-experienced technicians and build confidence and skill across the team

Features and benefits

- On-board identification and location of the most common mechanical faults (bearings, misalignment, unbalance, looseness) focus maintenance efforts on root cause, reducing unplanned downtime
- Fault severity scale with four severity levels help you prioritize maintenance work
- Repair recommendations advise technicians on corrective action
- On-board context sensitive help provide real-time tips and guidance to new users
- 2 GB expandable on-board memory provide enough space for your machinery's data
- Self-test functions ensure optimal performance and more time on the job
- Laser tachometer for accurate machine running speed promotes confident diagnoses
- Tri-axial accelerometer reduces measurement time by 2/3 over single axis accelerometers
- Viewer PC Software expands data storage and tracking capacity
- Color LCD display and intuitive multilingual, icon-based user interface promote use right out of the box

Specifications

(Check the Fluke web for detailed specifications)

Diagnostic specifications

Standard faults	Unbalance, looseness, misalignment and bearing failures
Analysis for	Motors, fans, blowers, belts and chain drives, gearboxes, couplings, centrifugal pumps, piston pumps, sliding vane pumps, propeller pumps, screw pumps, rotary thread/gear/lobe pumps, piston compressors, centrifugal compressors, screw compressors, closed coupled machines, spindles
Machine rotational speed range	200 rpm to 12000 rpm
Diagnosis details	Plain-text diagnosis, fault severity (slight, moderate, serious, extreme), repair details, cited peaks, spectra

Electrical specifications

Ranging	Automatic
A/D converter	4 channel, 24 bit
Usable bandwidth	2 Hz to 20 kHz
Sampling	51.2 kHz
Digital signal processing functions	Automatically configured anti-alias filter, high-pass filter, decimation, overlapping, windowing, FFT, and averaging
Sampling rate	2.5 kHz to 50 kHz
Dynamic range	128 dB
Amplitude accuracy	±0.1 dBV
FFT resolution	800 lines
Spectral windows	Hanning
Frequency units	Hz, orders, cpm
Amplitude units	in/sec, mm/sec, VdB (US), VdB (Europe)
Non-volatile memory	SD micro memory card, 2 GB internal + user accessible slot for additional storage

Included Accessories

Tri-axial TEDS accelerometer, accelerometer magnet mount, accelerometer mounting pad kit with adhesive, accelerometer quick disconnect cable, laser tachometer and storage pouch, smart battery pack with cable and adapters, shoulder strap, adjustable hand strap, Viewer PC application software, mini-USB to USB cable, getting started guide, illustrated quick reference guide, users manual CD-ROM, instructional training CD-ROM, hard carrying case.

Ordering Information

Fluke 810 Vibration Tester

Battery type: Lithium-ion, 14.8 V 2.55 Ah
Size (HxWxD): 186 x 267 x 70
Weight: 1.9 kg

Warranty: Three years on tester
 One year on sensor and tachometer

481 Radiation Detection Meter

Radiation safety quality assurance is top of mind for hospitals, nuclear power facilities, nuclear medicine laboratories, x-ray manufacturers, government agencies, state inspectors, emergency response and HAZMAT (hazardous materials) teams, and police and fire departments around the world.

With the 481 Fluke offers these professionals the versatility they need to get the job done and the quality they trust in a radiation-safety device.



481 Radiation Detection Meter



Fluke 481



Fluke 481 Radiation Detection Meter

The Fluke 481 Radiation Detection Meter is a portable and practical means for discovering irradiated goods, and for helping remediate contaminant and safety issues while minimally affecting performances. Ideal for detecting irradiated goods, equipment, surfaces or environments in industrial settings, the 481 Radiation Meter helps ascertain worker safety and compliance to national regulations.

Use of the Fluke 481 assures employees that radiation dangers are known, monitored and calculated for their security. Whenever radiation is found, a clear and quantifiable result provides handlers to comply with national guidelines while avoiding unnecessary steps that could stop procedures, impact productivity or lead to missed revenue.

- Detects skin-dose (beta particle) and deep-dose (gamma) and X-ray radioactivity

- Requires no adjustments; simple two button process
- Provides promptly read, correct value through autoranging capability
- Easily visible inside truck trailers and other low-light situations with automated backlight
- Works dependably inside or outside thanks to sealed case
- 30 % more precise than other available meters
- Delivers more than one week of uninterrupted functioning with two 9-volt alkaline batteries
- Proven in use by state and local governmental emergency response professionals, state inspectors, HAZMAT teams and nuclear power workers
- Measures both dose and dose-rate
- Valuable for contamination-detection, general radiation area metering, radiation-level monitoring, and hazardous materials assessment
- Rugged Fluke design

Specifications

General specifications	Fluke 481	Fluke 481-DESI
Radiation detected	Beta > 100 keV Gamma > 7 keV	
Operating ranges	0 mR/h to 5 mR/h (8 sec) 0 mR/h to 50 mR/h (2.5 sec) 0 mR/h to 500 mR/h (2 sec) 0 R/h to 5 R/h (2 sec) 0 R/h to 50 R/h (2 sec)	0 µSv/h to 50 µSv/h (8 sec) 0 µSv/h to 500 µSv/h (2.5 sec) 0 mSv/h to 5 mSv/h (2 sec) 0 mSv/h to 50 mSv/h (2 sec) 0 mSv/h to 500 mSv/h (2 sec)
Accuracy	Within 10 % of readings between 10 % and 100 % of full scale indication on any range, exclusive of energy response	
Detector	Chamber (cc volume air ionization) 349 cc Chamber wall (phenolic) 246 mg/cm ² Chamber window (mylar) 6.6 mg/cm ² Beta slide 440 mg/cm ²	
Automatic features	Auto-zeroing, auto-ranging, and auto-backlight	
Power requirements	Two 9 V alkaline, 200 hours operation	
Warm-up time	One minute	
Battery life	Four+ hours continuous use per battery pack (assumes 50 % brightness of LCD)	
Dimensions (W x D x H)	10 cm x 20 cm x 15 cm	
Weight	1.11 kg	
Display LCD analog/digital with backlight		
Analog	100 element bar graph 6.4 cm long. Bar graph is divided into 5 major segments, each labeled with the appropriate value for the range of the instrument	
Digital	2.5 digit display is followed by a significant zero digit depending on the operating range of the instrument. The units of measurement are indicated on the display at all times. Digits are 6.4 mm high. Low battery and freeze indicators are also provided on the display	
Modes		
Integrate mode	Operates continuously 30 seconds after the instrument has been turned on. Integration is performed even if the instrument is displaying in mR/h or R/h	
Freeze mode	Will place a tick mark on the bar graph display to hold on the peak displayed value. The unit will continue to read and display current radiation values	
Environmental		
Temperature range	-20 °C to 50 °C	
Relative humidity	0 % to 100 % (at 50 °C)	
Geotropism	< 1 %	

Ordering Information

Fluke 481	Ion Chamber Survey Meter
Fluke 481-DESI	DESI Ion Chamber Survey Meter, dose equivalent SI
190HPS	Single Unit Carrying Case

ATEX Certified Test Tools

The Fluke line of intrinsically safe tools is designed to meet the needs of technicians working in and around hazardous areas. The tools are ideal for environments in chemical plants, petro-chemical plants, oil platforms, refineries and other locations where risk of explosion exists. The products are easily recognizable from standard Fluke products by their lighter grey colour and red holster.



A brief look at ATEX

Intrinsic safety is a protection standard employed in potentially explosive atmospheres. Devices that are certified as “intrinsically safe” are designed to be unable to release sufficient energy, by either thermal or electrical means, to cause ignition of flammable material (gas, dust/particulates).

What is “Intrinsically Safe”?

Intrinsically safe standards apply to all equipment that can create one or more of a range of defined potential explosion sources:

- Electrical sparks
- Electrical arcs
- Flames
- Hot surfaces
- Static electricity
- Electromagnetic radiation
- Chemical reactions
- Mechanical impact
- Mechanical friction
- Compression ignition
- Acoustic energy
- Ionizing radiation

What industries are intrinsically safe products designed for?

- Petro-chemical
- Oil platforms and refineries
- Pharmaceutical
- Bulk materials (e.g. grain)
- Mining
- Pipelines
- Any environment where explosive gases are present

What is ATEX?

The primary intrinsically safe standard has been set in the European Union with the 9/94/EC Directive, commonly called ATEX (“Atmosphères Explosibles,” French for explosive atmospheres). The stated goal of the guidelines is to “help ensure the free movement of products in the European Union” by “minimizing the number of safeguard clause applications, at least those originating from divergent interpretations. The ATEX rules have been in place as a voluntary standard since 1 March 1996. The rules are mandatory on electrical and electronic equipment for use in environments subject to explosion hazard sold in the EU starting 1 July 2003. From

this date onwards, all products sold for use in explosive atmospheres must have ATEX certification and carry the distinctive symbol: Ⓔ

The Fluke Ex (IS) product line

Fluke is among the first manufacturers to produce handheld test tools according to the latest ATEX standards. The Fluke line of intrinsically safe tools is designed to meet the needs of technicians working in and around hazardous areas:

- Install, maintain and troubleshoot equipment by using the new Fluke 87V Ex Digital Multimeter
- Maintain and calibrate sensors, transmitters and control loops with the line of Ex field calibrators

The tools are ideal for environments in petro-chemical plants, oil platforms, refineries and other locations subject to risk of explosion.

Apart from having the ATEX markings, the visual difference between a standard Fluke tool and the corresponding Ex version is the different grey body colour and a red, conductive holster designed specifically to eliminate the potential for electrical discharge.

Inside, the Fluke Ex tools have been reengineered to reduce energy avoiding generation of heat and electrical sparks. They are premium products designed for ultimate safety.

Making sense of ATEX certification Fluke 707Ex is ATEX-compliant and is certified Ⓔ II 2 G EEx ia IIC T4— but what exactly does that mean?

Here a brief explanation of the ATEX certification designations.



ATEX certification 707Ex

Ⓔ	The ATEX examination mark. This sign is required on all devices used in European hazardous areas.
II 2 G	The classification of zones. “II” designates the tool is approved for all non-mining areas. “2” represents the category of the device, in this case the device is rated for the second most hazardous areas. “G” designates atmosphere, in this case gas, vapors and mist.
EEx	Explosion protection based on European Ex-regulations.
ia	The type of protection from explosion, in this case the energy in a device or connector has been reduced to a safe value.
IIC	Gas Group. “IIC” indicates compatibility with the most dangerous gas group.
T4	Temperature class gives the user the maximum temperature of a surface that may be in contact to the Ex atmosphere under fault conditions. T4 is rated at 135°C.

ATEX-certified Test Tools



Fluke intrinsically safe tools for tough measurement and calibration tasks



Fluke 87V Ex

Fluke 87V Ex Intrinsically safe version of the world's most popular multimeter

With its high performance, accuracy and motor drive compatibility, the Fluke 87V is the most popular industrial multimeter around. Now Fluke has introduced a new intrinsically safe version – the 87V Ex – for measurements in and around hazardous areas.

The Fluke 87V Ex has all the measurement and troubleshooting functions of the proven Fluke 87V. Unlike other ATEX-certified tools, it can be used both inside and outside the hazardous zone (ATEX Zones 1 & 2) without compromising performance or compliance. So there's no need to carry different tools for use in specific zones. It also has a built-in thermometer with TC probe, further reducing technicians' tool counts.

- ATEX safety rating II 2G EEx ia IIC T4
- EN61010-1 CAT III 1000V/CAT IV 600V electrical safety rating

See also page 15



Fluke 725Ex

Fluke 725Ex Intrinsically safe Multifunction Process Calibrator

The Fluke 725Ex intrinsically safe Multifunction Process Calibrator is powerful yet easy-to-use. Combined with the Fluke 700PEX Pressure Modules, the 725Ex is able to calibrate almost any process instrument likely to need service in any area where explosive gases may be present.

- ATEX safety rating II IG EEx ia IIB 171°C

See also page 104



1551A Ex/1552 Ex

1551A Ex and 1552A Ex "Stik" Thermometer

Finally, a digital substitute for your mercury-in-glass thermometers! Accurate and repeatable to ± 0.05 °C over its full range, the 1551A/1552A "Stik Thermometer is the new "gold standard" of industrial temperature calibration. Whether working outdoors in environments where potentially explosive gases may be present or on the floor of a processing plant, the intrinsically-safe, battery operated, portable reference thermometer is designed to go where you work.

- ATEX and IECEx compliant

See also page 57



Fluke 707Ex

Fluke 707Ex Fast, one-handed tool for loop checks

The Fluke 707Ex is the ideal, stand alone tool for calibration and maintenance of 4 to 20 mA control loops. It provides 24V loop power while measuring mA, and lets you measure and source/simulate mA with 1 μ A resolution.

- ATEX safety rating II 2G EEx ia IIC T4

See also page 109



Fluke 718Ex

Fluke 718Ex Self-contained Pressure Calibrator

The Fluke 718Ex offers a convenient, self contained solution for pressure measurements and calibration. With its internal pressure sensor and pump, it's ready for immediate, stand alone use. The pressure range can easily be extended to up to 200 bar with any of the 8 Fluke 700PEX Pressure Modules.

- ATEX safety rating II IG EEx ia IIC T4

See also page 108



Fluke 700Ex

Fluke 700Ex Pressure Modules

These intrinsically safe pressure modules for use with the Fluke 725Ex Multifunctional Process Calibrator and Fluke 718Ex Pressure Calibrator cover the most commonly used pressure calibration ranges from 0-25 mbar and 0-200 bar. There's a choice of 8 gage, differential and absolute modules.

- ATEX safety rating II 1G EEx ia IIC T4

See also page 112

General Accessories

The best test tools deserve accessories designed and manufactured to the same high quality and safety standards. So we also provide a comprehensive range of test leads, probes and clips, current clamps, temperature accessories and dedicated electronic and automotive accessories. And to protect your valuable instrument, choose a rugged Fluke tailor-made holster or case.



Electronic Test Leads, Probes & Clips

FLUKE®

Test Leads

TL910 Electronic Test Lead Set

- Very small 1 mm tips to access hard to reach test points
- Probe tip length up to 100 mm, test lead length: 1 m
- Included: 3 sets of spring loaded gold tips and 2 sets of stainless steel tips
- CAT II 1000 V, 3 A rating



TP912 Replacement Tips for TL910

- Replacement tips for TL910
- Five sets of gold plated and stainless steel tips



TL40 Retractable Tip Test Lead Set

- One pair (red, black) of test leads with sharp needle point tips adjustable to desired length from 0 to 76 mm
- Extra hard probe tips to provide long service life
- Flexible silicone insulated test leads
- CAT II 150 V, 3 A rating, UL listed

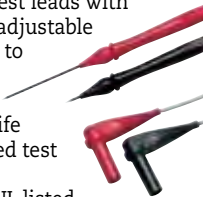

TL940 Mini-Hook Test Lead Set

- 1 pair (red, black) of test leads with multi-stacking 4 mm banana plugs and mini-hooks
- Mini-hooks attach to component leads up to 1.5 mm diameter
- 90 cm long PVC insulated leads
- 30 V rms or 60 V DC, 15 A



TL950 Mini-Pincer Test Lead Set

- 1 pair (red, black) of test leads with multi-stacking 4 mm banana plugs and mini-pincers
- Mini-pincers open to 2.3 mm
- 90 cm long PVC insulated leads
- 30 V rms or 60 V DC, 15 A



Test Leads / Patch Cords

TL960 Micro-Hook Test Lead Set

- 1 pair (red, black) of test leads with multi-stacking 4 mm banana plugs and micro-hooks
- Micro-hooks attach to component leads up to 1 mm diameter
- 90 cm long PVC insulated leads
- 30 V rms or 60 V DC, 15 A

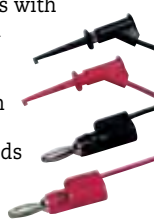

TL930 Patch Cord Set (60 cm)

- 1 pair (red, black) multi-stacking 4 mm banana plug patch cords
- Nickel-plated banana plugs
- 61 cm long PVC insulated leads
- 30 V rms or 60 V DC, 15 A



TL932 Patch Cord Set (90 cm)

- 1 pair (red, black) multi-stacking 4 mm banana plug patch cords
- Nickel-plated banana plugs
- 90 cm long PVC insulated leads
- 30 V rms or 60 V DC, 15 A



TL935 Patch Cord Kit (60, 90, 120 cm)

- 3 sets (red and black pairs) of multi-stacking 4 mm banana plug patch cords
- Nickel-plated banana plugs
- 60 cm, 90 cm, 120 cm long PVC insulated leads
- 30 V rms or 60 V DC, 15 A



Kits

TL80A-1 Basic Electronic Test Lead Kit

- One pair (red, black) each 1 meter long silicone test lead set, alligator clip and probe tip extender.
- C75 soft carrying case
- CAT II 300 V. UL listed



TP920 Test Probe Adapter Kit

- Set of push-on adapters for TL71 and TL75 test probes
- IC test adapters, extended probe tips, medium alligator clips (max. opening 7.6 mm)
- CAT I 300 V, 5 A rating



TL970 Hook and Pincer Kit

- TL940 Mini-Hook Test Lead Set
- TL950 Mini-Pincer Test Lead Set
- TL960 Micro-Hook Test Lead Set



TL81A Deluxe Electronic Test Lead Kit

- Includes components of TL80, plus one pair (red, black) each modular 1 meter long silicone test lead, test probe, hook-style and pinch style clip, alligator clip, IC probe tip adapter and spade lugs
- Quadfold soft carrying case
- CAT II 300 V. UL listed



TLK287 Electronic Master Test Lead Kit

- Includes modular leads, probes (black and red), minigrabber/jack set, medium alligator clips (black and red), spade lug/banana jack plated (set), couplers IEC1010 (black and red), micrograbbers and -leads (black and red)
- TL910 Electronic Test Lead Set
- Quadfold Pouch
- CAT III 1000 V (probes only)



BP980 Double Banana Plug Kit

- 5 pair (red, black) of double 4 mm banana plugs
- Each plug has 3.1 mm holes for mounting wires and components
- Brass plugs/jack, beryllium copper springs
- 30 V rms or 60 V DC, 15 A

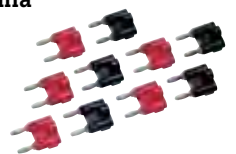

Industrial Test Leads, Probes & Clips

FLUKE®

Test Leads

TL71-1 Premium Test Lead Set

- One pair (red, black) comfort grip probes with silicone insulated, right-angle test leads
- Recommended for μV measurements
- CAT II 1000 V, 10 A rating. UL listed



TL75-1 Hard Point™ Test Lead Set

- One pair (red, black) comfort grip probes with PVC insulated, test leads with right-angle shrouded banana plugs
- Recommended for general purpose measurements
- CAT II 1000 V, 10 A rating. UL listed



TL76 All-in-one Test Lead Set

- One pair (red, black) 1.5 meter long silicone test leads with right angle shrouded banana plug
- Lantern tip (removable) for use with European wall sockets (4 mm \varnothing)
- Lantern tip can be removed for easy access to terminal blocks (2 mm \varnothing)
- Removable, insulated IC caps allow probing on closely spaced leads and compliance with GS38.
- Cat IV 600 V, CAT III 1000 V, 10 A rating. UL listed



Modular Test Leads

TL221 SureGrip™ Extension Lead Set

- One pair (red, black) of silicone insulated leads with straight connectors on both ends
- Reinforced strain relief
- Includes one pair (red, black) of female couplers
- Extends test leads by 1.5 m
- 600 V CAT IV, 1000 V CAT III, 10 A rating. UL listed



TL222 SureGrip™ Silicone Test Lead Set

- DMM test leads (red, black) with safety shrouded, standard diameter banana plugs
- Right angle connector on both ends
- Reinforced strain relief
- 1.5 meter silicone-insulated wire resists heat & cold
- CAT IV 600 V, CAT III 1000 V, 10 A rating. UL listed

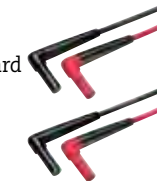

TL224 SureGrip™ Silicone Test Lead Set

- DMM test leads (red, black) with safety shrouded, standard diameter banana plugs
- Right angle connector on one end and straight connector on the other
- Reinforced strain relief
- 1.5 meter silicone-insulated wire resists heat & cold
- CAT IV 600 V, CAT III 1000 V, 10 A rating. UL listed



TL27 Heavy Duty Test Lead Set

- DMM test leads (red, black) with safety shrouded, standard diameter banana plugs
- Heavy duty EPDM insulation
- Length 1.5 m
- CAT III 1000V, 10A rating. UL listed



H900 Test Lead Holder

- Heavy duty construction with mounting holes
- Holder has 10 slots for wires up to 8 mm in diameter
- Over-all dimensions: 27.9 cm L x 8.9 cm W x 3.2 cm H



Kits

TL220-1 SureGrip™ Industrial Test Lead Kit

- AC220 SureGrip™ Alligator Clip Set
- TP238 SureGrip™ Insulated Test Probe Set
- TL222 SureGrip™ Silicone Test Lead Set (right to right)



TL223-1 SureGrip™ Electrical Test Lead Kit

- AC220 SureGrip™ Alligator Clip Set
- TP238 SureGrip™ Insulated Test Probe Set
- TL224 SureGrip™ Silicone Test Lead Set (straight to right)

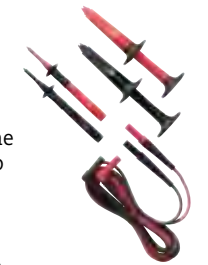

TL238 SureGrip™ High Energy Test Lead Kit

- TP238 SureGrip™ Insulated Tip Test Probes with less than 4 mm of exposed metal (GS38) with flexible removable finger banner
- TP280 20 cm Test Probe Extenders
- TL224 SureGrip™ Silicone Test Lead Set

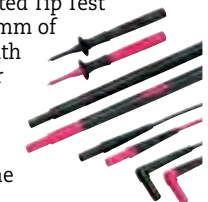

TLK-220 EUR SureGrip™ Accessory Kit

- AC220 SureGrip™ Alligator Clip Set
- AC285 SureGrip™ Large Jaw Alligator Clip Set
- TP74 Test Probe Set (4 mm)
- TL224 SureGrip™ Silicone Test Lead Set
- Large zippered soft case with moveable divider



SureGrip™ accessories are designed to improve steadiness in slippery hands. Rubber overmolded surfaces and finger-hugging curves give the user a comfortable, reliable grip on the accessory so they can focus on making an accurate measurement.

Industrial Test Leads, Probes & Clips

FLUKE®

Kits

TLK-225-1 SureGrip™ Master Accessory Kit

- AC220 SureGrip™ Alligator Clip Set
- AC280 SureGrip™ Hook Clip Set
- AC283 SureGrip™ Pincer Clip Set
- AC285 SureGrip™ Large Jaw Alligator Clip Set
- TP238 SureGrip™ Insulated Test Probe Set
- TL224 SureGrip™ Silicone Test Lead Set
- 6-Pocket Storage Pouch



TLK289 EUR Industrial Master Test Lead Kit

- C116, Soft Case
- AC220 Alligator Clip Set
- AC280 Hook Clip Set
- AC285 Large Jaw Alligator Clip Set
- TP74 Lantern Tip Test Probe Set
- TL224 Test Lead Set
- TPAK Hanging Kit
- 80BK-A Temperature Thermocouple



T5-KIT-1 Accessory Kit for use with T5

- This kit completes the offering of a T5 with add-on probes and carrying case.
- TP238 SureGrip™ Insulated Test Probe Set
 - AC285 SureGrip™ Large Jaw Alligator Clip Set
 - C33 Soft Meter Case



L215 SureGrip™ Kit with Probe Light and Extender

- L200 Probe Light
- TP280 20 cm Test Probe Extenders
- TP220 SureGrip Test Probes
- TL224 SureGrip Silicon Test Lead Set
- Foldable soft pouch with six pockets and hook-and-loop



Modular Test Probes

(for use with Modular Test Leads)

TP220-1 SureGrip™ Test Probe Set

- One pair (red, black) of Industrial test probes
- Sharp, 12 mm stainless steel tip provides reliable contact
- Flexible finger barrier improves grip
- Recommended for use with TL222 and TL224 test leads
- CAT II 1000 V, 10 A rating. UL listed



TP74 Lantern Tip Test Probe Set

- One pair (red, black)
- Tips include banana-style spring contacts with nickel-plated brass ends
- CAT III 1000 V, 10 A rating. UL listed



TLK290 Test Probe Kit

- Kit includes three flexible socket probes and a large alligator clip
- To be used on three phase sockets.
- Probes have flexible width test points that fit securely in 4 to 8 mm sockets.
- Test probe set to be used on motor and three phase sockets
- Safe contact e.g. in CEE 16 A and CEE 32 A plugs
- CAT II 1000 V, 8 A



TP1-1, TP2-1, TP38 SlimReach Test Probe Sets

- One pair (red, black) of slender probes for closely spaced or recessed terminals
- **TP1-1:** Flat blade design to hold securely in blade type wall sockets
- **TP2-1:** 2 mm diameter tip for electronics work. Also compatible with AC72.
- **TP38:** Insulated probe tip (designed to meet GS38 specs for United Kingdom).
- **TP1-1/TP2-1:** CAT II 1000 V
- **TP38:** CAT IV 600 V / CAT III 1000 V 10A rating, UL listed

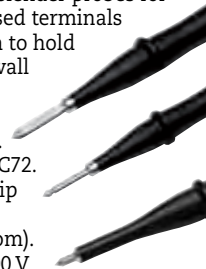

Modular Test Probes

(for use with Modular Test Leads)

TP80 Electronic Test Probe Set

- Recommended for use with TL222 and TL224
- One pair (red, black)
 - IC insulated cap prevents shortening of IC legs for probing high density components or boards
 - CAT III 1000 V, 10 A rating. UL listed



TLK291 Fused Test Probe Set

- One pair (red, black) fused test probes
- Designed to meet GS38 specs for United Kingdom
- CAT III 1000V, 0.5A
- Fuse rating: 500 mA/1000 V/FF/50 kA



FTP-1 SureGrip™ Fused Test Probes

- Built-in fuses for added protection
- 2 mm threaded probe tips include removable 4 mm lantern-style spring contacts
- Removable GS38 insulated IC caps for probing closely spaced leads
- CAT III 1000 V, CAT IV 600 V, 10A



FTPL-1 SureGrip™ Fused Test Probes with Leads

- FTP Fused Test Probes with built-in fuses for added protection
- Includes TL224 Silicone Insulated Test Leads
- CAT III 600 V, CAT IV 600 V, 10 A



New

AC285-FTP Alligator Clips and Adapters for FTP-1 or FTPL-1

- Enhance the usage of your Fluke fused test leads with this large alligator clip set. This accessory enables the use of AC285 alligator clips with FTP-1 fused probes.
- CAT III 600 V, CAT IV 600 V, 10 A



All accessories have a one year warranty

Industrial Test Leads, Probes & Clips

FLUKE®

Modular Clips

(for use with Modular Test Leads)

AC220 SureGrip™ Alligator Clip Set

- One pair (red, black) of small, insulated, nickel plated jaws
- Blunt tip grabs round screw heads up to 9.5 mm
- Recommended for use with TL222 and TL224 test leads
- CAT IV 600 V, CAT III 1000 V, 10 A rating. UL listed



AC280 SureGrip™ Hook Clip Set

- One pair (red, black) of nickel plated clips
- Profile narrows to 5.6 mm at tip, hook opening 6.4 mm at front, 2 mm at base
- Recommended for use with TL222 and TL224 test leads
- CAT IV 600 V, CAT III 1000 V, 3 A rating. UL listed



AC283 SureGrip™ Pincer Clip Set

- One pair (red, black) of nickel plated pincers open to 5 mm
- 11.4 cm flexible insulated shaft
- Recommended for use with TL222 and TL224 test leads
- CAT IV 600 V, CAT III 1000 V, 1 A rating. UL listed



Modular Clips

(for use with Modular Test Leads)

AC285 SureGrip™ Large Jaw Alligator Clip Set

- One pair (red, black) of large alligator clips with nickel-plated steel jaws
- Multi-purpose tooth pattern grips anything from fine gauge wire to a 20 mm bolt
- Recommended for use with TL222 and TL224 test leads
- CAT IV 600 V; CAT III 1000 V, 10 A rating. UL listed



AC87 Heavy Duty Bus Bar Clip Set

- One pair (red, black) of flat, right angle design for connecting to bus bars
- Adjustable collar provides 2 ranges of jaw openings up to 30 mm
- CAT III 600 V, 5 A rating. UL listed



AC89 Heavy Duty Insulation Piercing Test Clip

- Single probe pierces 0.25 to 1.5 mm insulated wire
- Small pin allows self-healing of the insulation
- CAT IV 600V, CAT III 1000 V, 5 A rating. UL listed



Push-on Clip

(for use with TL71 and TL75 Test Lead Sets)

AC172 Alligator Clip Set

- Slide-on alligator clips (red, black) for TL175/TL71/TL75
- Jaws provide 8 mm opening
- CAT IV 600 V, CAT III 1000 V, 10 A rating. UL listed



All accessories have a one year warranty

Fluke TL175 TwistGuard™ Test Leads

Fluke TL175 TwistGuard™ Test Leads

The new Fluke TL175 TwistGuard™ Test Leads are innovative test leads with adjustable length test tips for use in changing measurement situations. By simply twisting the test lead the user can change the exposed probe tip length from 19 mm to 4 mm.

TL175 TwistGuard™ Test Leads offer:

- Patented extendable tip sheath that meet new electrical safety requirements to reduce tip exposure while providing the versatility needed for most measurements
- New WearGuard™ lead wire wear indication. Each test lead is covered by two layers of silicone insulation; inner contrasting color is exposed when the leads are nicked, scuffed, or otherwise damaged and in need of replacement
- Double insulated silicone leads. TL175 withstands high temperatures and remain flexible in cold temperatures.
- Extra-heavy strain relief on both probe-end and plug-end, testing beyond 30,000 bends without failure.
- Universal input plugs compatible with all instruments that accept standard 4 mm shrouded banana plugs
- Ratings: CAT II 1000 V, CAT III 1000 V, CAT IV 600 V, 10 A max., Pollution Degree 2
- TL175E includes removable 4 mm lantern tips for versatility
- Probes always show correct category rating for tip being used
- Environmental ratings: -20 °C to 55 °C, altitude: 2000 m
- Conforms to latest safety standard EN61010-031: 2008
- One-year warranty
- Also available as Test Probe Set, TP175 and TP175E

New



TL175



TL175E



TP175

Automotive Accessories

Piercing Clips

TP81 and TP82 Insulation Piercing Clip Set

- Banana jack accepts all DMM and banana jack leads
- Available for 4 mm input, modular connection with TP81 or available as a 2 mm input to slip onto probe tips with the TP82
- Tested to 60 V DC



TP84 Oxygen Sensor Insulation Piercing Clip

- Banana jack accepts all DMM and banana jack leads (4 mm)
- Tested to 60 V DC



Probe Pins

TP88 Rigid Back Probe Pin Set

- Slides onto test probes measuring 2 mm
- Tested to 60 V DC

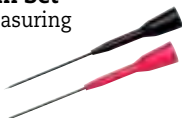

TP40 Automotive Back Probe Pins (five)

- Banana jack accepts all DMM and banana jack leads (4 mm)
- Tested to 60 V DC

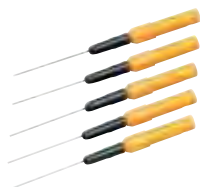

Banana Plugs

BP880 BNC to Female Double Stacking Banana Plug BP881 BNC to Male Double Stacking Banana Plug

- Allows for hands-free testing in controlled voltage environments 500 VRMS maximum
- Banana plug is nickel-plated, beryllium copper for low contact resistance
- The BNC shell is plated for tarnish resistance
- Operating temperature +50°C maximum

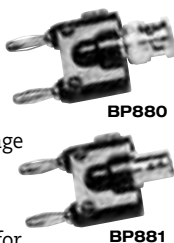

Pressure Module

PV350 Pressure Vacuum Module

- Compatible with all Fluke and most popular DMMs
- Digital pressure and vacuum measurements in a single module
- Transducer sealed in 316 stainless steel compatible with variety of liquids and gases
- Measures vacuum to 76 cm Hg
- Display results in English (psig or Hg) or metric (kPa or cm Hg) units
- Measures pressure to 500 psig (3447 kPa)

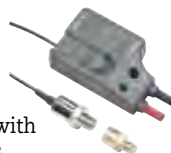

Test Leads

TL28A Automotive Test Lead Set

- Flexible silicone insulated leads are heat and cold resistant
- CAT I 30 V, 10 A



TLK281-1 SureGrip™ Automotive Test Lead Kit

- Kit contains:
- TP81 Insulation Piercing Clip Set
 - TL224 Suregrip™ Silicone Test Lead Set
 - TP220 Suregrip™ Test Probe Set
 - AC220 Suregrip™ Alligator Clip Set
 - AC285 Suregrip™ Large Jaw Alligator Clip Set
 - Soft Case

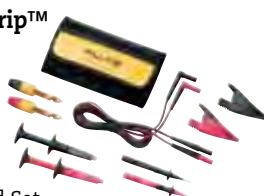

TLK282-1 SureGrip™ Deluxe Automotive Test Lead Kit

- Kit contains:
- TP81 Insulation Piercing Clip Set
 - TP40 Automotive Back Probe Pins (five)
 - TL224 Suregrip™ Silicone Test Lead Set
 - TP238 Suregrip™ Insulated Test Probe Set
 - AC220 Suregrip™ Alligator Clip Set
 - AC285 Suregrip™ Large Jaw Alligator Clip Set
 - AC280 Suregrip™ Hook Clip Set
 - Soft Case



TL 82 Automotive Pin & Socket Adapter Kit

This set of male and female adapters allows you to make firm connection to pin and socket connectors.

- Kit contains:
- Retractable shrouded test lead set
 - Complete set of 8 pin-and-socket adapters with flexible tips
 - One red and black in different sizes
 - Rated to 60 V DC

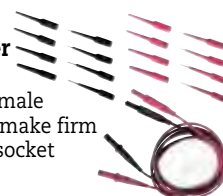

Current Probe

90i-610s AC/DC Current Probe (600 A)

- Current Range: 2 to 600A DC or AC Peak
- Basic Accuracy (DC to 400Hz): ± (2% of reading + 1A)
- Output Signal: 100A range: 10mV/A 600A range: 1mV/A
- Frequency Range: 40Hz to 400Hz
- Working Voltage: 600V AC rms
- Maximum Conductor Diameter: 34 mm



Inductive Pick-up

RPM80 Inductive Pick-up

- Provides RPM readings



ScopeMeter Accessory Kits

SCC128 Automotive Accessory Kit (120 Series)



SCC198 Automotive Accessory Kit (190 Series)



These kits provide a host of accessories that allow you to easily and quickly make measurements on automotive electronic systems using a 120 or 190 Series ScopeMeter.

Current Clamps

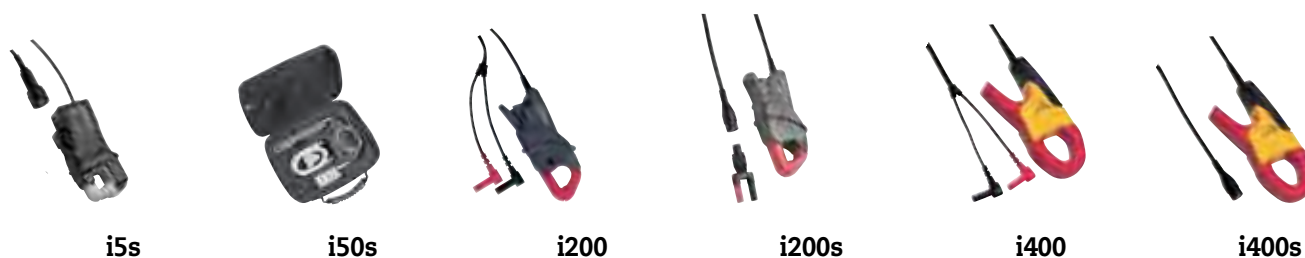

Specifications AC models

	i5s	i50s	i200	i200s	i400	i400s
Nominal current range(s)	5 A	3/30 AC RMS or DC	200 A	20 A 200 A	400 A	40 A 400 A
Continuous AC current range	0.01 A - 6 A	30 A cont. 50 A<10 sec	0.5 A - 200 A	0.1 - 24 A 0.5 A - 200 A	5 A - 400 A	0.5 - 40 A 5 A - 400 A
Highest current	70 A	30 A cont. 50 A<10 sec	240 A	240 A	1000 A	1000 A
Lowest measurable current	10 mA	10 mA	0.5 A	0.5 A	1 A	0.5 A
Basic accuracy (48-65 Hz) ¹⁾	1%	± 5% typical DC to 100 kHz	1% + 0.5 A	1.5% + 0.5 A	2% + 0.15	2% + 0.15
Useable frequency	40 Hz - 5kHz	DC to 50 MHz	40 Hz - 10 kHz	40 Hz - 10 kHz	45 Hz - 3 kHz	45 Hz - 3 kHz
Max. working voltage	600 V AC	300 V AC RMS or DC	600 V AC	600 V AC	1000 V	1000 V
Maximum conductor diameter	15 mm	5 mm	20 mm	20 mm	32 mm	32 mm
Output level(s)	400 mV/A	1/100 mV/A	1 mA/A	100 mV/A 10 mV/A	1 mA /A	10 mV/A 1 mV/A
Battery, battery life		External Power				
Output cable (m)	2.5	2	1.5	2.0	1.5	2.5
Shrouded banana plugs			●		●	
BNC connector	•	●		●		●
BNC to banana adapter included				●		
Safety	CAT III, 600 V	CAT I 300 V	CAT III, 600 V	CAT III, 600 V	CAT III 1000 V / CAT IV 600 V	CAT III 1000 V / CAT IV 600 V

¹⁾ Basic Accuracy: % reading + floorspec

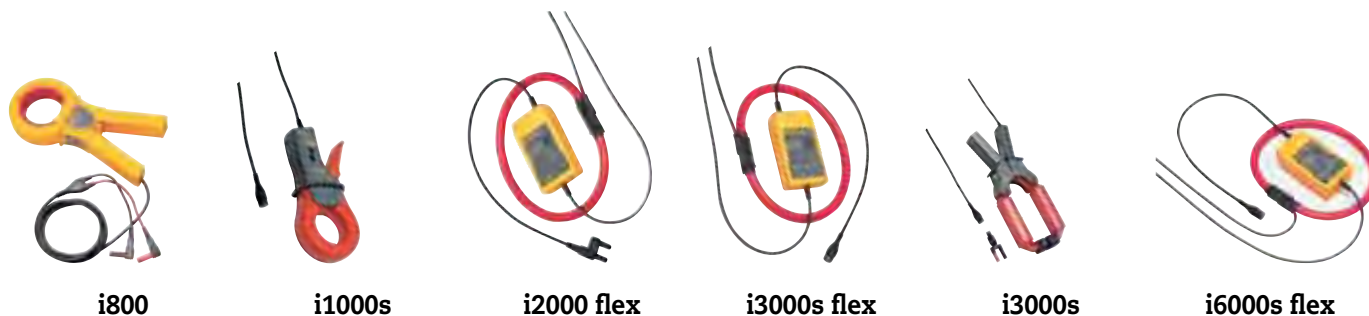

	i800	i1000s	i2000 flex	i3000s flex-24 i3000s flex-36	i3000s	i6000s flex-24 i6000s flex-36
Nominal current range(s)	800 A RMS	10 A 100 A 1000 A	20 A 200 A 2000 A	30 A 300 A 3000 A	30 A 300 A 3000 A	60 A 600 A 6000 A AC
Continuous AC current range	0.1 A - 800 A RMS	0.1 A - 10 A 0.1 A - 100 A 1 A - 1000 A	1 A - 20 A 2 A - 200 A AC RMS 30 A - 2000 A	1 A - 30 A 2 A - 300 A AC RMS 30 A - 3000 A	1 A - 30 A 1 A - 300 A 1 A - 2400 A	1 A - 6000 A AC RMS
Highest current	1500 A	2000 A	2500 A AC RMS	3500 A AC RMS	4000 A	6000 A
Lowest measurable current	0.1 A	0.1 A	1 A	1 A	1 A	1 A
Basic accuracy (48-65 Hz) ¹⁾	0.10%	1% + 1 A	1%	1%	2% + 2 A	± 1% of range
Useable frequency	30 Hz - 10 kHz	5 Hz - 100 kHz	10 Hz - 20 kHz (-3dB)	10 Hz - 50 kHz (-3dB)	10 Hz - 100 kHz	10 Hz to 50 kHz
Max. working voltage	600 V AC RMS or DC	600 V AC	600 V AC RMS	600 V AC RMS	600 V AC	600 V AC RMS or DC
Maximum conductor diameter	54 mm	54 mm	178 mm	Flex-24 178 mm Flex-36 275 mm	64 mm	Flex-24 170 mm Flex-36 275 mm
Output level(s)	1 mA/A	100 mV/A 10 mV/A 1 mV/A	100 mV/A 10 mV/A 1 mV/A	100 mV/A 10 mV/A 1 mV/A	10 mV/A 1 mV/A 0.1 mV/A	50 mV/A 5 mV/A 0.5 mV/A
Battery, battery life			200 hours	400 hours		400 hours
Output cable (m)	1.6	1.6	0.5	0.5	2.1	0.5
Shrouded banana plugs	●		●	n/a	●	●
BNC connector		●	n/a	●	●	●
BNC to banana adapter included			n/a	●	●	●
Safety	CAT III, 600 V	CAT III, 600 V	CAT III, 600 V	CAT III, 600 V	CAT III, 600 V	CAT III, 600 V

¹⁾ Basic Accuracy: % reading + floorspec

Current Clamps



Specifications AC/DC Models

	80i-110s	i30	i30s	i310s	i410	i1010
Measurement type	Hall sensor	Hall sensor	Hall sensor	AC/DC	Hall sensor	Hall sensor
Nominal current range(s)	10 A, AC/DC 100 A, AC/DC	20 A AC RMS or DC	20 A AC RMS or DC	30/300 A AC RMS or 45/450 A DC	400 A, AC/DC	600 A, AC 1000 A, DC
Continuous current range	0.1 A - 10 A AC/DC 1 A - 100 A AC/DC	30 A AC Peak	30 A AC Peak	100 mA - 300 A AC RMS or 450 A DC	1 A - 400 A AC/DC	1 A - 600 A, AC 1 A - 1000 A, DC
Highest current	140 A - 2 kHz	30 A AC Peak	30 A AC Peak	300 A AC RMS or 450 A DC	400 A	1000 A
Lowest measurable current	0.1 A	50 mA	50 mA	100 mA	0.5 A	0.5 A
Basic accuracy ¹⁾	3% + 50 mA (@ 10 A)	± 1% of reading ±2 mA	± 1% of reading ±2 mA	±1% of reading	3.5% + 0.5 A	2% +0.5 A
Useable frequency	DC - 100 kHz	DC to 20 kHz (-0.5dB)	DC to 100 kHz (-0.5dB)	DC to 20 kHz	DC - 3 kHz	DC - 10 kHz
Zero error adjustment	●	manual adjust via thumbwheel	manual adjust via thumbwheel	Manual	●	●
Max. working voltage	600 V	300 V AC RMS	300 V AC RMS	300 V AC RMS or DC	600 V	600 V
Maximum conductor diameter	11.8 mm	19 mm	19 mm	19 mm	30 mm 2 x 25 mm	30 mm 2 x 25 mm
Output level(s)	100 mV/A 10 mV/A	100 mV/A	100 mV/A	10/1 mV/A	1 mV/A	1 mV/A
Battery, battery life	9 V, 55 h	30 hours typical	30 hours typical	30 hours	9 V, 60 h	9 V, 60 h
Output cable length (m)	1.6	1.5	2	2	1.6	1.6
Shrouded banana Plugs	●	●	n/a	●	●	●
BNC connector	●	n/a	●	●	●	●
BNC to banana adapter included	●	n/a	●	●	●	●
Safety	CAT II, 600 V CAT III, 300 V	CAT III, 300 V	CAT III, 300 V	CAT III 300 V	CAT III, 600 V	CAT III, 600 V

¹⁾ Basic Accuracy: % reading + floorspec

Current Clamp Compatibility Chart



- i410 Kit AC/DC Current Clamp (400A) with soft case**
i1010 Kit AC/DC Current Clamp (1000A) with soft case
- Combination of current clamp with carrying case
 - Zipped soft case with moveable divider
 - Soft case is large enough to hold a meter

	113/114/115/116/117	175/177/179	187/189	233	287/289	271I / 281I	8845A/8846	8808A	77 IV	83V/87V	88V	43B	430 Series II	123/124	125	190 Series II / 225C/S	1577/1587	715	724	725	753/754	787	789
AC Models																							
i5s													●		●	●							
i200	4	●	●	●	●	●	●	●	●	●	●			●	●	●	●					●	●
i200s	●	●	●	●	●	●	●	●	●	●	●			●	●	●	●				●	●	●
i400	●	●	●	●	●	●	●	●	●	●	●											●	●
i400s	2	2	2	2	2	2	2	2	2	2	2	●	●	●	●	●	2				2	2	2
i430 flexi-TF													●										
i800	4	●	●	●	●	●	●	●	●	●	●						●					●	●
i1000s	2	2	2	2	2	2	2	2	2	2	2	●		●	●	●	2				2	2	2
i2000 flex (new version)	●	●	●	●	●	●	●	●	●	●	●	3	3	3	3	3	●					●	●
i3000s	●	●	●	●	●	●	●	●	●	●	●	●	●	●	●	●					●	●	●
i3000s flex	●	●	●	●	●	●	●	●	●	●	●	●	●	●	●	●					●	●	●
i6000s flex	●	●	●	●	●	●	●	●	●	●	●						●				●	●	●
AC/DC Models																							
i30	●	●	●	●	●	●	●	●	●	●	●						●					●	●
i30s	●	●	●	●	●	●	●	●	●	●	●	●	●	●	●	●							●
80i-110s	2	2	2	2	2	2	2	2	2	2	2	●	●	●	●	●					2	2	2
i310s	●	●	●	●	●	●	●	●	●	●	●	●	●	●	●	●						●	●
i410 / i410 kit	●	●	●	●	●	●	●	●	●	●	●			3	3	3	●	1	1	1	1	●	●
i1010 / i1010 kit	●	●	●	●	●	●	●	●	●	●	●			3	3	3	●	1	1	1	1	●	●
Other																							
90i-610s*	2	2	2	2	2	2	2	2	2	2	2			●	●	●	2				2	2	2

* For specifications of 90i-610s see page 125
 1 For DC only
 2 Requires PM 9081 (see page 86)
 3 Requires PM 9082 (see page 86)
 4 115, 117 only

Temperature Accessories

Contact Probes

80PK-22 SureGrip™ Immersion Probe

- Type-K thermocouple for use in liquids and gels
- Measurement range: -40 to 1090°C
- Probe length: 21.3 cm



80PK-24 SureGrip™ Air Probe

- Type-K thermocouple for use in air and non-caustic gas measurements
- Bead protected by perforated baffle
- Measurement range: -40 to 816°C
- Probe length: 21.6 cm



80PK-25 and 80PT-25 SureGrip™ Piercing Probe

- 80PK-25: Type-K thermocouple suitable for food industry, liquids and gels
- 80PT-25 operates with T-type thermometers
- Measurement range: 80PK-25: -40 to 350°C, 80PT-25: -196 to 350°C
- Probe length: 10.2 cm



80PK-26 SureGrip™ General Purpose Probe

- Type-K thermocouple with tapered tip for use in air, non-caustic gas and surface applications
- Measurement range: -40 to 816°C
- Probe length: 21.2 cm

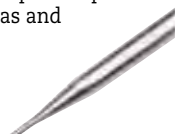

80PK-27 SureGrip™ Industrial Surface Probe

- Type-K thermocouple for surfaces in rugged environment
- Durable ribbon sensor
- Measurement range: -127 to 600°C
- Probe length: 20.3 cm



80PK-1 and 80PJ-1 Bead Probe

- 80PK-1: Type-K thermocouple for general purpose applications
- 80PJ-1 operates with J-type thermometers
- Measurement range: -40 to 260°C
- Probe length: 1 m lead wire

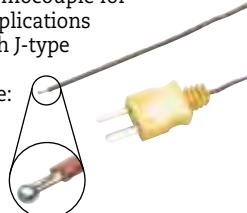

80PK-3A Surface Probe

- Type-K thermocouple for flat or curved surfaces such as plates and rollers
- Measurement range: 0 to 260°C
- Probe length: 9.5 cm

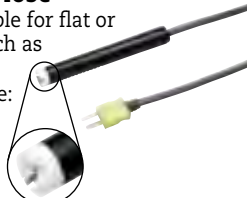

80PK-8 / 80PK-10 Pipe Clamp Temperature Probe

- Type-K thermocouple for fast temperature and superheat measurements of pipe surfaces
- Durable ribbon sensor
- Measurement range: -29 to 149°C for pipe diameters from 6.4 to 34.9mm (80PK-8) and 32 mm to 64 mm (80PK-10)



80PK-9 and 80PJ-9 General Purpose Probe

- 80PK-9: Type-K thermocouple surface, air and non-caustic gases
- 80PJ-9 operates with J-type thermometers
- Measurement range: -40°C to 260°C
- Probe length: 15.3 cm

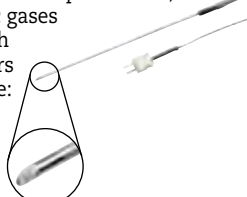

80PK-11 Velcro Temperature Probe

- Type-K thermocouple for hands free measurement of HVAC temperature measuring applications
- Total length of cable: 1m (0.5m in cable, 0.5m in Velcro cuff insulation material; Hytrel)
- Measurement range: -30°C to 105°C



DMM Probes

80AK-A Thermocouple Adapter

- Adapts Type-K thermocouple mini-connector to dual banana plug inputs
- Measurement range and accuracy: probe dependent
- Suitable for low voltage applications (below 30 V AC, 60 V DC)



80BK-A Integrated DMM Probe

- Type-K thermocouple with standard banana jack
- Convenient one piece construction
- Compatible with DMMs with temperature measurement functions
- Measurement range: -40 to 260°C



80TK Thermocouple Module

- Converts a DMM to a thermometer
- For use with type-K thermocouples in low voltage applications (below 24 V AC, 60 V DC)
- Measurement range: -50 to 1000°C (probe dependent)

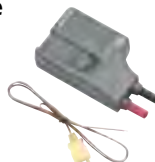

80T-150UA Universal Temperature Probe

- Compatible with Fluke DMM
- High accuracy, fast reading for low voltage (below 24 V AC, 60 V DC) applications
- Measurement range: -50 to 150°C
- Output: 1 mV/°C or 1 mV/°F (switchable)

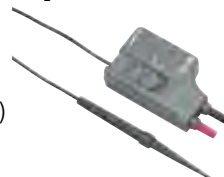



SureGrip™ accessories are designed to improve steadiness in slippery hands. Rubber overmolded surfaces and finger-hugging curves give the user a comfortable, reliable grip on the accessory so they can focus on making an accurate measurement.

Temperature Accessories

Other Temperature Accessories

80PK-18 Pipe Clamp Temperature Probe Kit

- 80PK-8 Pipe Clamp Temperature Probe
- 80PK-10 Pipe Clamp Temperature Probe
- Soft Case



80CK-M & 80CJ-M type K & J Male Mini-Connectors

- Isothermal screw terminal for K or J wire
- Suitable for up to 20 gauge thermocouple wire
- Color coded to industry standards (K-yellow, J-black)
- Two per package

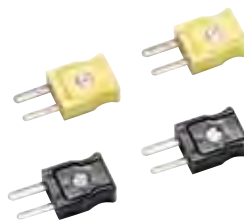

Thermocouple Plug Kits 700TC1

- A kit of 10 mini-plug connectors
- Type J (black), one
 - Type K (yellow), one
 - Type T (blue), one
 - Type E (purple), one
 - Type R/S (green), one
 - Type B or CU (white), one
 - Type L (J-DIN) (blue), one
 - Type U (T-DIN) (brown), one
 - Type C (red), one
 - Type N (orange), one



80PK-EXT, 80PJ-EXT and 80PT-EXT Extension Wire Kits

- Extending and repairing J, K or T-type thermocouple wires
- Kit includes 3 meters of thermocouple wire and 1 pair of male/female mini-connectors
- Maximum continuous exposure temperature: 260°C
- 80PK-EXT is compatible with K-type thermometers, 80PJ-EXT is designed for J-type thermometers and PT-EXT for T-type thermometers

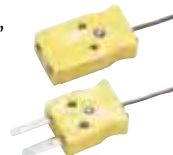

700TC2

- A kit of 7 mini-plug connectors
- Type J (black), two
 - Type K (yellow), two
 - Type E (purple), one
 - Type T (blue), one
 - Type R/S (green), one

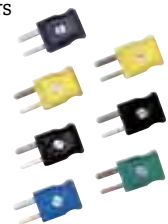

Temperature Probe Compatibility Chart

	113/114/115/116/117	175/177	179	233	287/289	271I / 281II	8845A/8846A/8808A	771V	83V	87V	88V	43B	120 Series	190 Series II / 225C/S	1577	1587	51/52/53/54 II	561	566/568	66/68	705/707	714	715	724	725	753/754	787	789
Contact Probes																												
80PK-1 ... 80PK-27	1	1	2	2	2	2	1	1	1	2	2	1	1	1	1	2	●	●	●		1	●	1	●	●	●	1	1
80PJ-1, 80PJ-9																	●	●	●			●		●	●	●		
80PT-25	1																●					●		●	●	●		
DMM probes																												
80AK-A	●3)		●	●	●	●				●	●					●												
80BK-A	●3)		●	●	●	●				●	●					●												
80TK		●					●	●	●			●	●	●	●							●		●		●	●	●
80T-150UA		●	●	●	●	●	●	●	●			●	●	●	●							●		●		●	●	●
Miscellaneous																												
80CK-M	1	1	2	2	2	2	1	1	1	2	2	1	1	1	1	2	●	●	●		1	●	1	●	●	●	1	1
80CJ-M																	●	●	●			●		●	●	●		
80PK-EXT4)	1	1	2	2	2	2	1	1	1	2	2	1	1	1	1	2	●	●	●		1	●	1	●	●	●	1	1
80PJ-EXT																	●	●	●			●		●	●	●		
80PT-EXT																	●	●	●			●		●	●	●		
700TC1, 700TC2																	●	●	●			●		●	●	●		
80PR-60																				●								

1) Requires 80TK
 2) Requires 80AK
 3) Fluke 116 only
 4) Also requires 80CK-M

Cases and Holsters

Soft Cases

Zipped carrying cases protect your meter; most cases come with belt loops so your meter is stored conveniently on your tool belt.



C195

- Zipped carrying case with storage compartments
- Allows hand or shoulder use



C789

- Large fabric carrying case with 3 compartments, removable handle and shoulder strap



C550 Tool Bag

- Steel reinforced frame
- Rugged ballistic cloth with heavy duty hardware
- Large zippered storage compartment with 25 pockets
- Weather resistant
- Carry all your tools to the job



Cases & Holsters Compatibility Chart

		113/114/115/116/117	175/177/179	233	287/289	271 / 281	77 IV	83V/87V/88V	T5	T50	T100 Series	321/322	333/334/335/336/337/902	353/355	1503/1507/1577/1587	9040/9062	1735/1740 Series	430 Series II	438/120 Series	190 Series II	922	971	5152/53/54 II	561	566/568	570 Series	61	636/668	705/707	712/714/715/717	718	724/725/726	753/754	787	789			
Soft Cases	Size (HxWxD) mm																																					
C12A	172 x 128 x 38	•																																				
C23	225 x 95 x 58	•								•		•																										
C25	218 x 128 x 64	•	•																																			
C33	280 x 115 x 55																																					
C35	220 x 140 x 65	•	•	•																																		
C43	318 x 230 x 90																																					
C50	192 x 90 x 38																																					
C75	179 x 103 x 26																																					
C90	205 x 90 x 72		•																																			
C115	240 x 205 x 75	•	•																																			
C116	240 x 230 x 65	•	•	•	•	•	•	•	•																													
C125	192 x 141 x 58																																					
C195	231 x 513 x 231																																					
C280	230 x 185 x 65																																					
C345	240 x 360 x 200																																					
C437-II																																						
C550	333 x 513 x 231																																					
C781	269 x 141 x 90																																					
C789	308 x 256 x 77																																					
C799	305 x 229 x 165																																					
Hard cases																																						
C20	256 x 154 x 106																																					
C100	397 x 346 x 122		•	•																																		
C101	305 x 360 x 105		•	•																																		
C120	346 x 397 x 128																																					
C290	410 x 474 x 135																																					
C435	565 x 476 x 305																																					
C800	230 x 385 x 115																																					
C1600	260 x 390 x 200																																					
CXT80	28 x 32 x 13																																					
CXT170	28 x 32 x 13																																					
CXT280	28 x 32 x 13																																					
Leather Cases																																						
C510	287 x 179 x 106		•																																			
C520A	256 x 154 x 106																																					
Holsters																																						
C10	154 x 77 x 45																																					
H80M	190 x 95 x 43																																					
Other																																						
H3	231 x 90 x 64																																					
H5	192 x 90 x 38																																					
H6	302 x 178 x 57																																					
Hanging Kit (see page 132)																																						
ToolPak		•	•	•	•	•	•	•	•	•	•	•	•	•	•	•	•	•	•	•	•	•	•	•	•	•	•	•	•	•	•	•	•	•	•	•	•	

Cases and Holsters

Hard Cases

C20 Meter Case

- Heavy duty case with carrying handle and accessories storage compartment
- Top cover snaps onto back to serve as tilt stand



C100 Meter and Accessory Case

- Tough polypropylene case



C101 Hard Case

The hard case that fits all Fluke industrial test tools. Configure the diced foam interior to store and protect what you need to carry with you.

- Tough polypropylene exterior shell
- Interior cavity measures



C120 and C290 Cases

- Heavy duty cases with accessory storage compartments



C435 Hard Rolling Case

- Watertight hard case with rollers for 430 Series, 1735 and 1740 Series Power Quality products and accessories. The configurable foam securely holds any of these instruments during transit.



C800 Meter and Accessory Case

- Tough polypropylene case
- Accessories and manual compartments
- Detachable lid



C1600 Meter and Accessories Case

- Rugged molded plastic case
- Deep interior large enough to hold and protect your tools
- Lift out tray keeps everything organized
- Snap open compartment on top of lid



CXT80, CXT170, CXT280 Rugged Pelican Hard Case

- Unbreakable, watertight, airtight, dustproof, chemical resistant and corrosion proof case



Holsters

C10 Meter Holster

- Snap-on yellow holster absorbs shocks and protects meter from rough handling
- Includes built-in stand and hanger loop



H80M Holster + Magnetic Hanger

- Snap-on yellow holster absorbs shocks and protects meter from rough handling
- Magnet, hook and loop straps
- General purpose hanger



H3 Clamp Meter Holster

- Fabric holster absorbs shocks and protects meter from rough handling.
- Built-in pocket for lead storage
- Convenient belt-loop with snap



H5 Electrical Tester Holster

- Rugged fabric holster includes flap for lead storage and built-in belt loop
- Fits Fluke T3 and T5 testers



H6 Infrared Thermometer Holster

- Durable nylon holster
- For Fluke 63, 66 and 68 Infrared Thermometers



Leather Cases

C510 Leather Meter Case

- Oiled genuine top grain cowhide
- Rugged construction with heavy duty stitching and reinforced rivets
- Large tool belt loop and top flap to secure meter
- Holds most Fluke DMMs, Thermometers, and Process Calibrators



C520A Leather Tester Case

- Oiled genuine top grain cowhide
- Oil tanned for long life
- Rugged construction with heavy duty stitching and reinforced rivets
- Large tool belt loop and top flap to secure tester
- Holds Fluke Electrical Testers



Software and other Accessories

Software FlukeView® Forms

FlukeView Forms increases the power of your Fluke tool by enabling you to document, store and analyze individual readings or series of measurements, then convert them into professional-looking documents. FlukeView Forms supports the following multimeters:



FlukeView Forms Compatibility Chart

FVF Option	Instrument	Cable**	Application Level
FVF-UG	Software only upgrade, Any instrument that supports Flukeview Forms Software	No Cable included	FVF Full (includes Designer)
FVF-SC2	Fluke 280 Series, 789, 1550B, 1653B, 568, 180 Series*, 53B, 54B	USB / IR	
FVF-SC4	Fluke 8808A, 8845A, 8846A, 45*, 975	USB / Serial	FVF BASIC
FVF-BASIC	Fluke 280 Series, 789, 1550B, 1653B, 180 Series*	USB / IR	
FVF-SC5	8808A, 8845A, 8846A, 45*	USB / Serial	

* Obsolete
 ** USB cables are not supported for Microsoft Windows NT 4.0

Hanging Kit

ToolPak (TPAK)

The meter hanging solution

- Kit includes, universal hanger clips (2), hook & loop straps (2 lengths) and strong magnet
- Combine components to meet most hanging needs

See page 130 for compatibility chart



IR189USB

IR to USB interface cable (included with FVF-SC2 and FVF-Basic)

- For customers who want to upgrade from their existing RS232 cable
- Small adapter to connect the cable to the 189, 287, 289, 1653B or the 1550B is included.



Make extended logging easier

BP189 High Capacity Battery Enclosure (for Fluke 180 Series DMM)

- Expand the battery life of your Fluke 187/189 up to 450 hours (over two weeks of continuous use).
 - Houses 4 'C' cell batteries.
 - CAT III 1000 V, CAT IV 600 V
- Batteries and meter sold separately



Fiber Optics

FOM Fiber Optic Meter

The Fluke Fiber Optic Meter (FOM) helps you test and maintain fiber optic cables without having to buy a whole new meter. Plug the FOM directly into any DMM with a mV dc function and a 10 MΩ input impedance and quickly and accurately verify fiber optic cable system loss. Light sources and patch cords sold separately.



FOS 850 & FOS 850/1300 Fiber Optic Light Sources

A variety of light sources allow you to test different cable lengths.

Other Accessories

Lights

L200 Probe Light

- Attaches to any Fluke test probe
- Bright white LED
- 120 hours of battery life



L205 Mini Hat Light

- Rugged high-intensity Xenon worklight
- Attaches to a baseball cap
 - Includes a hat clip
 - Includes two AAA batteries
 - Waterproof



L206 Deluxe LED Hat Light (hard hat not included)

- Attach it to a hard hat, a baseball cap, or even a panel door for all the light you need.
- 3 super bright white LEDs – never burn out
 - Special hard-hat attachment included
 - 40-hour battery life
 - Includes three AAA batteries



L210 Probe Light + Probe Extender

- Includes L200 Probe Light and TP280 Test Probe Extenders
- 20 cm probe extenders keep hands away from live circuits
- Extender fits between modular test probe and test lead (total reach 30 cm)



Stray Voltage Adapter

SV225 Stray Voltage Adapter

Stray voltage can appear in electrical installations, due to the capacity between wires. This may result in erroneous readings on high impedance meters.



The SV225 solves this without compromising safety.

- On energized wires, the meter will indicate the real voltage.
- On non-energized circuits the meter will read close to zero (even if there are stray voltages).
- It can be used with all modern meters with standard input spacing.
- Rated CAT III 1000 V, CAT IV 600 V



High Voltage Probes

80K-6 and 80K-40

A high voltage probe that allows a multimeter to measure up to 6,000V or 40,000V respectively. Intended for low energy applications only



TL225-1 SureGrip™ Stray Voltage Adapter Test Lead Kit

Kit includes:

- SV225 Stray Voltage Eliminator
- TL224 SureGrip™ Silicone Test Lead Set (right to straight)
- TP238 SureGrip™ Insulated Test Probe Set
- C75 Accessory Case



Meter Cleaners

MC6 MeterCleaner™ Wipes (6-pack)

MC50 MeterCleaner™ Wipes (50-pack)

- Pre-moistened wipe removes dirt, oil and grease
- One wipe easily cleans one meter
- Safe on rubber, plastic and for environment (non-toxic)



Fuse and Warranty Information



Fuse Replacement Information

A	V	IR	Size in mm	Part nr qty 1
63mA (slow)	250V		6.35x32	163030
125mA (slow)	250V		6.35x32	166488
250mA (slow)	250V		6.35x32	166306
315 mA	1000V	10KA	6.35x32	2279339
440mA	1000V	10kA	10.3x34.9	943121
500mA	250V	1500A	5x20	838151
630mA	250V	1500A	5x20	740670
1A	600V	10kA	10.3x34.9	830828
1A	500V	50kA	6.35x 32	2530449
1.25A	600V		6.35x32	2040349
3.15A	500V		6.35x32	2030852
11A	1000V	17kA	Replaced by 11A, 1000V, 20kA fuse; 803293	
11A	1000V	20kA	10.3x38.1	803293
15A	600V	100kA	10.3x38.1	892583
20A	600V		Replaced by 15A, 600V, 100kA fuse; part nr. 892583	

See the back of your Fluke test tool or user manual for the fuses installed.
 For manuals check the Fluke website in the product section.
 For Fuse Replacement Guide check the Fluke website in the service section.

Product Warranty

Each Fluke product is warranted to be free from defects in material and workmanship under normal use and service, for the warranty period listed unless local law requires a longer period. The warranty period is listed in the ordering information section of the product specification and begins on the date of shipment. This warranty extends only to the original buyer or end-user customer of a Fluke authorized reseller, and does not apply to fuses, disposable batteries or to any product which, in Fluke's opinion, has been misused, altered, neglected or damaged by accident or abnormal conditions of operation or handling. Fluke warrants that software will operate substantially in accordance with its functional specifications for 90 days and that it has been properly recorded on non-defective media. Fluke does not warrant that software will be error free or operate without interruption.

Lifetime Warranty

Each Fluke 20, 70, 80, 170, 180 and 280 Series DMM purchased after October 1, 1996 will be free from defects in material and workmanship for its lifetime. This warranty does not cover fuses, disposable batteries and damage from accident, neglect, contamination, misuse or abnormal conditions of operation or handling, including overvoltage failures caused by use outside the DMM's specified rating, or normal wear and tear of mechanical components. This warranty covers the original purchaser only and is not transferable. For ten years from the date of purchase, this warranty also covers the LCD. Thereafter, for the lifetime of the DMM, Fluke will replace the LCD for a fee based on then current component acquisition costs.

To establish original ownership and prove date of purchase, please complete and return the registration card accompanying the product.

Service

Fluke will, at its discretion, repair at no charge, replace or refund the purchase price of a defective product purchased through a Fluke authorized sales outlet and at the applicable international price. Fluke reserves the right to charge for importation costs of repair/replacement parts if product purchased in one country is sent for repair elsewhere.

Send defective product with a description of the problem to the nearest Fluke Authorized Service Center, postage and insurance prepaid. Fluke will pay return transportation for product repaired or replaced in-warranty. Before making any non-warranty repair, Fluke will estimate cost and obtain authorization, then invoice you for repair and return transportation.

THIS WARRANTY IS YOUR ONLY REMEDY. NO OTHER WARRANTIES, SUCH AS FITNESS FOR A PARTICULAR PURPOSE, ARE EXPRESSED OR IMPLIED. FLUKE IS NOT LIABLE FOR ANY SPECIAL, INDIRECT, INCIDENTAL OR CONSEQUENTIAL DAMAGES OR LOSSES, INCLUDING LOSS OF DATA, ARISING FROM ANY CAUSE OR THEORY. AUTHORIZED RESELLERS ARE NOT AUTHORIZED TO EXTEND ANY DIFFERENT WARRANTY ON FLUKE'S BEHALF.

Since some states do not allow the exclusion or limitation of an implied warranty or of incidental or consequential damages, this limitation of liability may not apply to you.



Blank writing area with horizontal yellow lines.

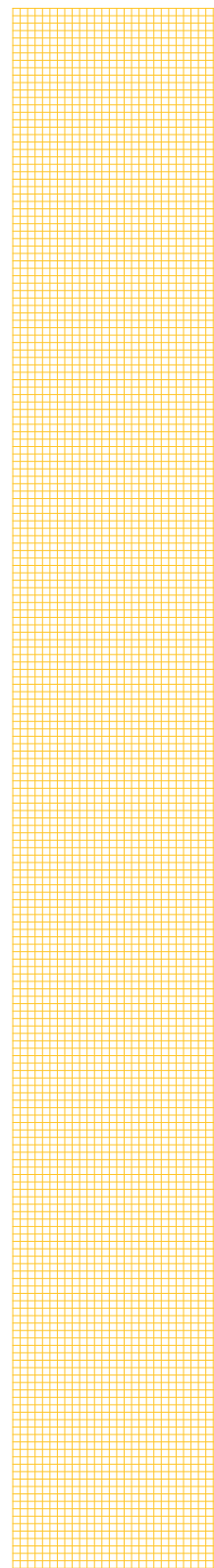

FLUKE®

Fluke. *Keeping your world
up and running.®*

Fluke Corporation

P.O. Box 9090
Everett, WA USA 98206

Web: www.fluke.com

Fluke Europe B.V.

P.O. Box 1186
5602 BD Eindhoven
The Netherlands

Web: www.fluke.eu

For more information call:

In the U.S.A. (800) 443-5853

or Fax (425) 446-5116

In Europe/M-East/Africa +31 (0)40 2 675 200

or Fax +31 (0)40 2 675 222

In Canada (905) 890-7600

or Fax (905) 890-6866

From other countries +1 (425) 446-5500

or Fax +1 (425) 446-5116

Fluke (UK) Ltd.

52 Hurricane Way
Norwich
Norfolk
NR6 6 JB
United Kingdom

Tel.: (020) 7942 0700

Fax.: (020) 7942 0701

E-mail: industrial@uk.fluke.nl

Web: www.fluke.co.uk

© Copyright 2012, Fluke Corporation.
All rights reserved.

Printed in the Netherlands, 01/12

Data subject to alteration without notice.

Pub_ID: 11882-eng